

JACKSON SUBDIVISION

FARR WEST CITY, WEBER COUNTY, UTAH
A PART OF THE SOUTHEAST QUARTER OF SECTION 26,
TOWNSHIP 7 NORTH, RANGE 2 WEST, SALT LAKE BASE & MERIDIAN
MAY 2023

SURVEYOR'S CERTIFICATE

I, MATT PRETL, DO HEREBY CERTIFY THAT I AM A REGISTERED PROFESSIONAL LAND SURVEYOR IN THE STATE OF UTAH IN ACCORDANCE WITH TITLE 58, CHAPTER 22, PROFESSIONAL ENGINEERS AND PROFESSIONAL LAND SURVEYORS ACT; AND I HAVE COMPLETED A SURVEY OF THE PROPERTY DESCRIBED ON THIS PLAT IN ACCORDANCE WITH SECTION 17-23-17 AND HAVE VERIFIED ALL MEASUREMENTS, AND HAVE PLACED MONUMENTS AS REPRESENTED ON THIS PLAT, AND HAVE HEREBY SUBDIVIDED SAID TRACT INTO TWO (2) LOTS, KNOWN HEREAFTER AS JACKSON SUBDIVISION IN FARR WEST CITY, WEBER COUNTY, UTAH, AND HAS BEEN CORRECTLY DRAWN TO THE DESIGNATED SCALE AND IS TRUE AND CORRECT REPRESENTATION OF THE HEREIN DESCRIBED LANDS INCLUDED IN SAID SUBDIVISION, BASED UPON DATA COMPILED FROM RECORDS IN THE WEBER COUNTY RECORDER'S OFFICE AND FROM SAID SURVEY MADE BY ME OR UNDER MY SUPERVISION ON THE GROUND, I FURTHER HEREBY CERTIFY THAT THE REQUIREMENTS OF ALL APPLICABLE STATUTES AND ORDINANCES OF WEBER COUNTY CONCERNING ZONING REQUIREMENTS REGARDING LOT MEASUREMENTS HAVE BEEN COMPLIED WITH.

SIGNED THIS 20TH DAY OF NOVEMBER, 2023.

MATT PRETL P.L.S.
UTAH LAND SURVEYOR LICENSE NO. 10437995



BOUNDARY DESCRIPTION

A PART OF THE SOUTHEAST QUARTER OF SECTION 26, TOWNSHIP 7 NORTH, RANGE 2 WEST OF THE SALT LAKE BASE AND MERIDIAN.

BEGINNING AT A POINT ON THE EAST RIGHT-OF-WAY LINE OF 2000 WEST STREET, POINT ALSO BEING THE NORTHWEST CORNER OF THE FARR WEST LIMITED COMPANY PROPERTY, TAX ID. NO. 19-017-0105 LOCATED 585.15 FEET NORTH 89°36'22" WEST AND 901.32 FEET NORTH 00°29'54" EAST FROM THE SOUTHEAST CORNER OF SAID SECTION 26;

RUNNING THENCE NORTH 00°29'54" EAST 496.77 FEET (NORTH 00°15'00" WEST 496.775 FEET BY RECORD) ALONG SAID EAST RIGHT-OF-WAY LINE TO THE SOUTHWEST CORNER OF THE JOY AND RANDY SALAZAR PROPERTY, TAX ID. NO. 19-017-0061; THENCE SOUTH 89°14'07" EAST 279.45 FEET (EAST 278.50 FEET M/L BY RECORD) ALONG THE SOUTH LINE OF SAID SALAZAR PROPERTY TO THE WEST RIGHT-OF-WAY LINE OF INTERSTATE 15; THENCE ALONG SAID WEST RIGHT-OF-WAY LINE THE FOLLOWING TWO (2) COURSES; (1) SOUTH 02°10'49" WEST 113.77 FEET; AND (2) SOUTHERLY ON A NON-TANGENT CURVE TO THE RIGHT ALONG THE ARC OF A 11409.16 FOOT RADIUS CURVE, A DISTANCE OF 383.08 FEET, CHORD BEARS SOUTH 05°58'13" WEST 383.06 FEET, HAVING A CENTRAL ANGLE OF 01°55'26" TO THE NORTHEAST CORNER OF SAID FARR WEST LIMITED COMPANY PROPERTY; THENCE NORTH 89°36'23" WEST 239.58 FEET (WEST 236.38 FEET M/L BY RECORD) ALONG THE NORTH LINE OF SAID FARR WEST LIMITED COMPANY PROPERTY TO THE POINT OF BEGINNING. CONTAINING 2.997 ACRES.

OWNER'S DEDICATION AND CERTIFICATION

WE THE UNDERSIGNED OWNERS OF THE HEREIN DESCRIBED TRACT OF LAND, DO HEREBY SET APART AND SUBDIVIDE THE SAME INTO LOTS AS SHOWN ON THE PLAT AND NAME SAID TRACT THE JACKSON SUBDIVISION, AND DO HEREBY DEDICATE, GRANT AND CONVEY TO FARR WEST CITY, WEBER COUNTY, THOSE CERTAIN STRIPS SHOWN AS PUBLIC UTILITY EASEMENTS AND MUNICIPAL UTILITY EASEMENTS FOR PUBLIC AND PRIVATE UTILITY PURPOSES AS SHOWN HEREON, THE SAME ALSO ENCOMPASSES PROVISION FOR DRAINAGE AND IRRIGATION MATTERS, AND FOR THE ACCESS, INSTALLATION, MAINTENANCE AND OPERATION OF SAID UTILITY LINES. WE HEREBY DEDICATE AN IRRIGATION EASEMENT TO WESTERN IRRIGATION COMPANY AND/OR THE EXISTING IRRIGATION DITCH USERS FOR THE EXISTING IRRIGATION DITCH AS SHOWN ACROSS LOT 2 - THE OWNER RESERVES THE RIGHT TO RELOCATE SAID DITCH. SUCH ALSO APPLIES TO THE EXISTING IRRIGATION DITCH THAT RUNS SOUTH-TO-NORTH ALONG THE PROJECT FRONTAGE. WE HEREBY DEDICATE THE SHARED ACCESS SHOWN AS THE SOLE ACCESS LOCATION FROM THE HIGHWAY FOR LOTS 1 AND 2 - THE REMAINDER OF THE FRONTAGE IS DECLARED AS "NON-ACCESS." WE HEREBY DECLARE THE PLAT NOTES SHOWN HEREON TO BE EFFECTIVE AND BINDING.

IN WITNESS WE HAVE HERE UNTO SET OUR SIGNATURE THIS 20th DAY OF November, 2023.
Glenda Jackson, Registered Agent of B & G Property Management, LLC

LIMITED LIABILITY COMPANY ACKNOWLEDGMENT

STATE OF UTAH)
COUNTY OF WEBER)
ON THIS 20th DAY OF November, 2023, PERSONALLY APPEARED BEFORE ME, GLENDA JACKSON, WHO BEING BY ME DULY SWORN DID SAY AND ACKNOWLEDGE THAT SHE IS A REGISTERED AGENT OF B & G PROPERTY MANAGEMENT LLC, A UTAH LIMITED LIABILITY COMPANY ("LLC"), WHICH LLC IS THE OWNER OF THE REAL PROPERTY LISTED HEREIN, AND EXECUTED THE FOREGOING INSTRUMENT AS THE AUTHORIZED AGENT OF THE LLC, AND THAT SAID AUTHORIZATION TO SIGN ON BEHALF OF THE LLC CAME PURSUANT TO A RESOLUTION OF THE MANAGERS, THE CERTIFICATE OF ORGANIZATION AND/OR THE OPERATING AGREEMENT OF THE LLC.

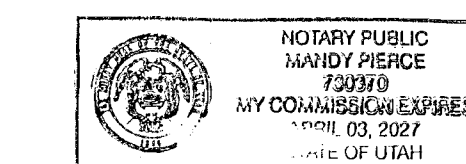
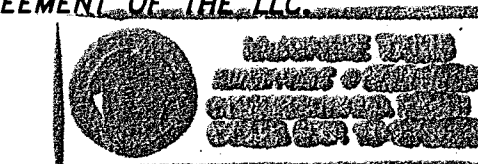
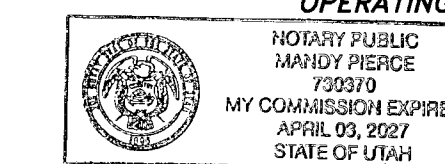

WEBER COUNTY RECORDER

ENTRY NO. 3306942 FEE PAID \$54.00
FILED FOR RECORD AND RECORDED 01-DEC-2023
1:58 PM IN BOOK 96 OF OFFICIAL RECORDS, PAGE 76 RECORDED FOR GLENDA JACKSON

LEANN H. KILTS
COUNTY RECORDER
BY: [Signature] DEPUTY

FARR WEST CITY COUNCIL ACCEPTANCE

THIS IS TO CERTIFY THAT THIS SUBDIVISION PLAT, THE DEDICATION OF STREETS AND OTHER PUBLIC WAYS AND FINANCIAL GUARANTEE OF PUBLIC IMPROVEMENTS ASSOCIATED WITH THIS SUBDIVISION THEREON ARE HEREBY APPROVED AND ACCEPTED BY THE CITY COUNCIL OF FARR WEST CITY, UTAH, THIS 20th DAY OF November, 2023.

BY: [Signature] MAYOR
ATTEST: [Signature] RECORDER

FARR WEST CITY PLANNING COMMISSION

THIS IS TO CERTIFY THAT THIS SUBDIVISION PLAT WAS DULY APPROVED BY THE FARR WEST CITY PLANNING COMMISSION ON THE 30th DAY OF November, 2023.

[Signature] FARR WEST CITY PLANNING COMMISSION CHAIRMAN

FARR WEST ATTORNEY

I CERTIFY THAT THE REQUIREMENTS OF ALL APPLICABLE STATUTES AND ORDINANCES PREREQUISITE BY THE STATE OF UTAH AND THE ORDINANCES OF FARR WEST CITY OF THE FOREGOING PLAT AND DEDICATIONS HAVE BEEN COMPLIED WITH. DATED THIS 30th DAY OF November, 2023.

[Signature] SIGNATURE

FARR WEST CITY ENGINEER

THIS PLAT WAS APPROVED BY THE FARR WEST CITY ENGINEER THIS 27th DAY OF November, 2023.

[Signature] CITY ENGINEER

NARRATIVE

THE PURPOSE OF THIS SURVEY WAS TO ESTABLISH AND SET THE PROPERTY CORNERS OF THE TWO LOT SUBDIVISION AS SHOWN AND DESCRIBED HEREON. THIS SURVEY WAS ORDERED BY BRAD JACKSON. THE CONTROL USED TO ESTABLISH THE PROPERTY CORNERS WAS HAI ROS NO. 3264 AND THE EXISTING WEBER COUNTY SURVEYOR MONUMENTATION SURROUNDING SECTION 26, TOWNSHIP 7 NORTH, RANGE 2 WEST, S.L.B.&M.

THE BASIS OF BEARING IS THE SOUTH LINE OF THE SOUTHEAST QUARTER OF SAID SECTION WHICH BEARS NORTH 89°36'22" WEST, UTAH NORTH, STATE PLANE, CALCULATED N.A.D.83 BEARING.

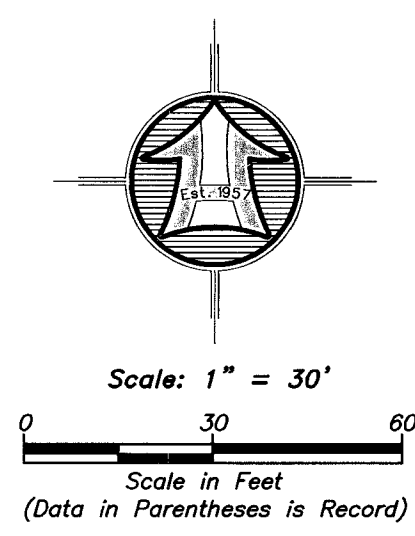

- Subject Property Line
- Interior Lot Lines
- Adjoining Property Line
- Previous Property Line
- Centerline
- Public Utility Easement (PUE)/Municipal Utility Easement (MUE)
- Fence Line
- Street Monument
- Found rebar set by others
- Set 5/8"x24" Rebar With Cap
- Section Corner
- Power Pole

This map is provided solely for the purpose of assisting in locating the property and Cottonwood Title Insurance Agency, Inc. assumes no liability for variation, if any, with any actual survey.

- NOTE: 1 - All public utility easements (P.U.E. / M.U.E.) are 15.0 foot wide unless otherwise noted.
- 2 - Easement Recorded May 17, 1966, Entry no. 1406843, Book 1806, Page 2925, may affect Subdivision, unable to plot.
- 3 - At the time the East / West ditch is relocated, the easement for the ditch will be vacated.

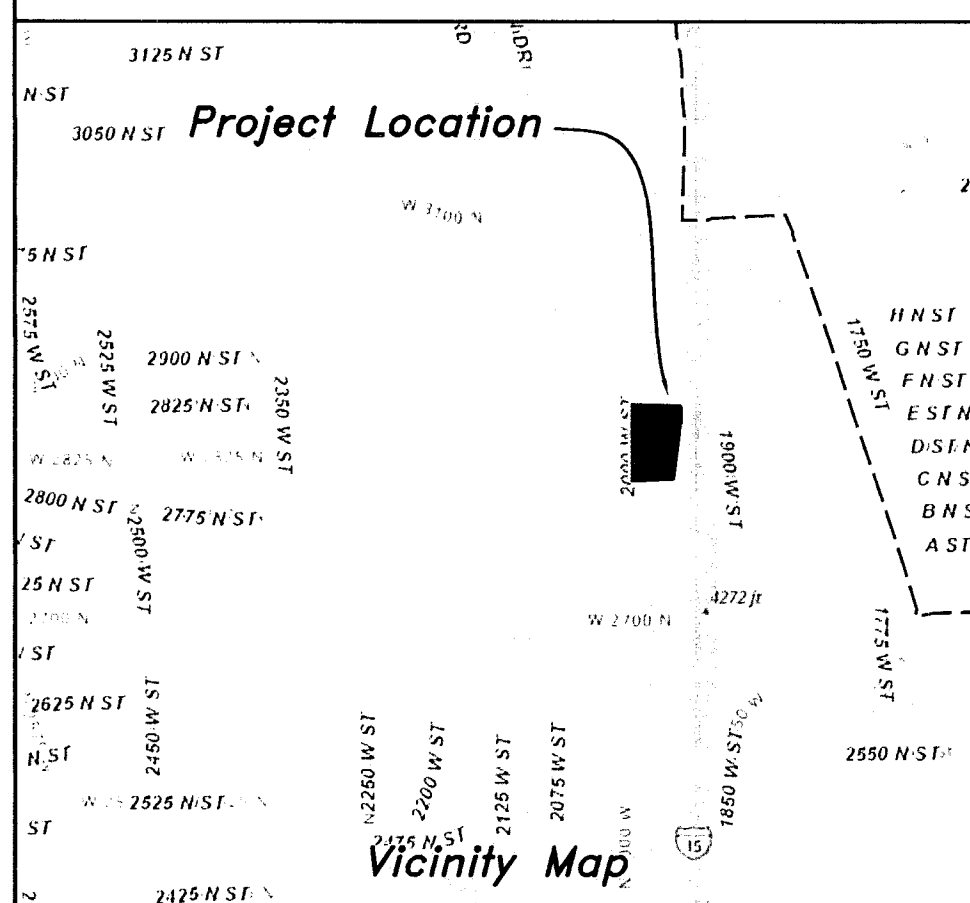

Developer: BRAD JACKSON
3243 NORTH 2700 WEST
FARR WEST, UT 84404
(801) 540-7000

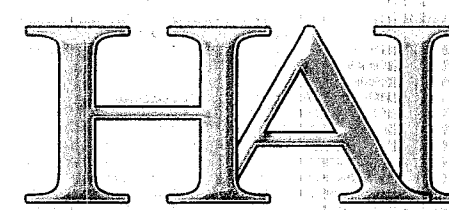

HANSEN & ASSOCIATES, INC.
Consulting Engineers and Land Surveyors
538 North Main Street, Brigham, Utah 84302
Visit us at www.haies.net
Brigham City Ogden Logan
(435) 723-3491 (801) 399-4905 (435) 752-8272
Celebrating over 65 Years of Business

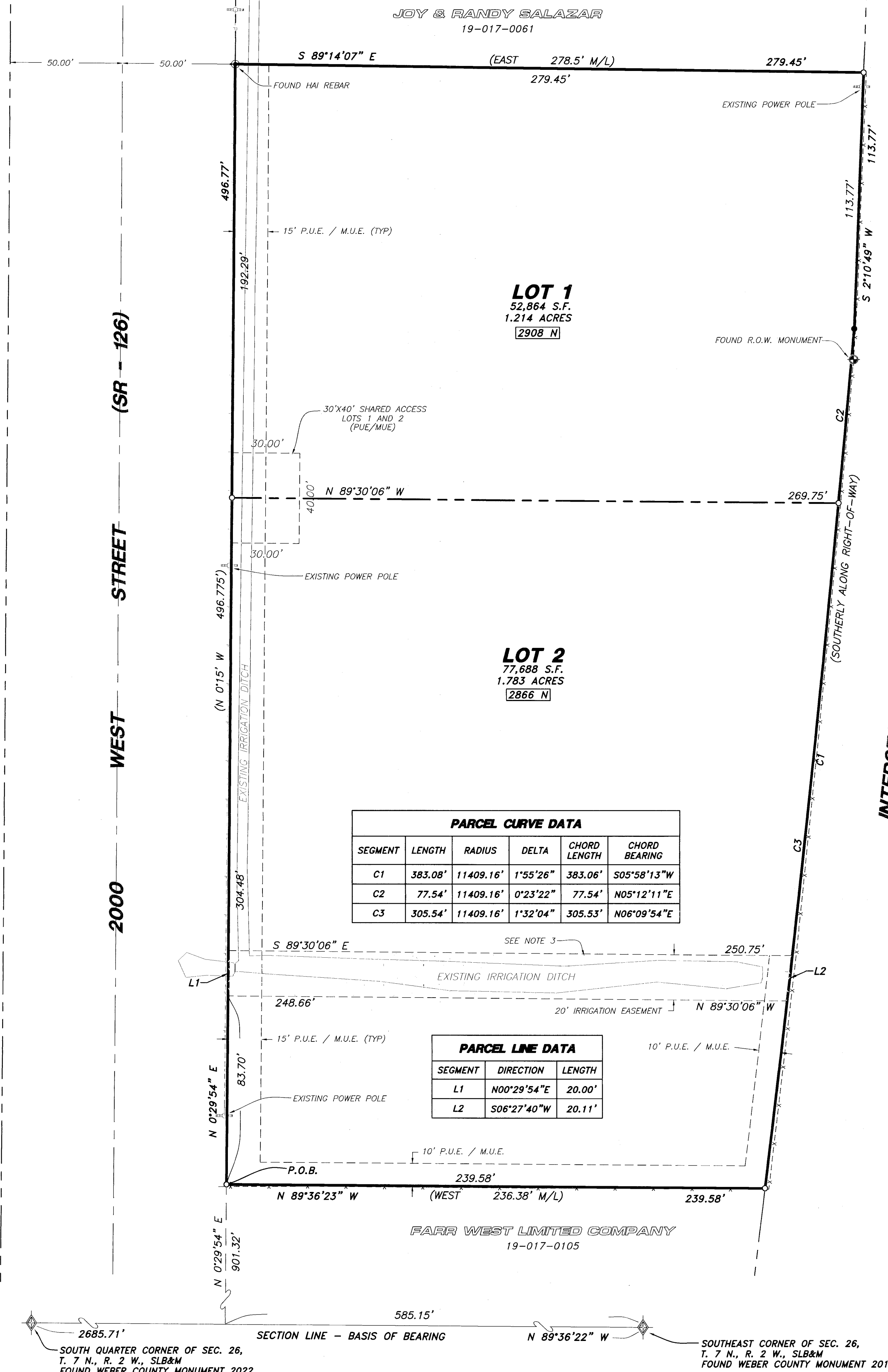

SEGMENT	LENGTH	RADIUS	DELTA	CHORD LENGTH	CHORD BEARING
C1	383.08'	11409.16'	1°55'26"	383.06'	S05°58'13"W
C2	77.54'	11409.16'	0°23'22"	77.54'	N05°12'11"E
C3	305.54'	11409.16'	1°32'04"	305.53'	N06°09'54"E

SEGMENT	DIRECTION	LENGTH
L1	N00°29'54"E	20.00'
L2	S06°27'40"W	20.11'