



ENT 4667:2021 PG 1 of 65
ANDREA ALLEN
UTAH COUNTY RECORDER
2021 Jan 08 3:44 pm FEE 116.00 BY RA
RECORDED FOR AMERICAN FORK CITY

STORM WATER FACILITY AGREEMENT

Rockwell Ranch Properties

THIS AGREEMENT, is made and entered into this 26 day of October, 2020, by and between RWR PROPERTY HOLDINGS, LLC (hereinafter referred to as "Owner", and American Fork City (hereinafter referred to as the "City"), a Municipal Corporation.

RECITALS

WHEREAS, the Owner desires to improve, develop or redevelop real property located at approximately 550 S. 1100 W. in American Fork City, Utah County, State of Utah (hereinafter referred to as the "Property"), which is more particularly described in Exhibit A attached hereto;

WHEREAS, said development requires the installation and maintenance of storm water facilities (hereinafter referred to as "Facilities") to be constructed according to designs and plans approved by the City;

WHEREAS, the Owner, for and in behalf of its administrators, executors, successors, heirs, or assigns, including any homeowners association, recognizes and agrees that the health, safety, and welfare of the citizens of the City require that the Facilities be constructed and adequately maintained on the Property throughout the life of the development; and

NOW, THEREFORE, in consideration of the foregoing, the mutual covenants contained herein, and the following terms and conditions, the parties hereto agree as follows:

**SECTION 1
FACILITIES**

Facilities include all storm water detention and control structures, flood control devices, or other improvements, which may include, but is not limited to all pipes, channels, or other structures and infrastructure built to convey storm water to the Facilities, as well as all structures, improvements, and vegetation provided to control the quantity and quality of the storm water which are required by the City in the site plan attached hereto as Exhibit B.

**SECTION 2
FACILITIES CONSTRUCTION**

The Owner shall, at its sole cost and expense, construct the Facilities in accordance with the plans and specifications for the development approved by the City. Owner understands and agrees that modifications may be needed to make the system work properly after the Facilities are installed and agrees to make modifications and adjustments as may be necessary and required by the City.

Approved as to form:
Attorney for American Fork City

SECTION 3 MAINTENANCE

The Owner shall, at its sole cost and expense, adequately maintain the Facilities in good working condition acceptable to the City and in accordance with the schedule of long term maintenance activities agreed to by the parties and attached hereto as Exhibit C. Adequate maintenance is herein defined as follows: 1) keeping the Facilities in good working condition so that the Facilities are performing their design functions, 2) performing facility inspections and repairs as may be needed, and 3) replacing and/or modifying portions, or all of the system, as may be needed to maintain the intended function of the facility.

SECTION 4 EASEMENT

The Owner hereby grants permission to the City, its authorized agents, and employees to enter upon the Property and to inspect the Facilities whenever the City deems it necessary. Whenever possible, the City shall provide notice prior to entry. Inspections by the City shall be conducted in a reasonable manner and at reasonable times, as determined appropriate by the City. The purpose of the inspection shall be to determine and ensure that the Facilities are being adequately maintained, are continuing to perform in an adequate manner, and are in compliance with all laws, regulations, and approved plans and specifications. The Owner hereby grants a twenty-five (25) foot access easement in favor of the City with the midpoint of the easement lying over the midpoint of the Facilities identified in the attached plan. This easement shall be limited in scope to allow only those actions which are necessary to allow the City to inspect, ensure adequate maintenance, and to cause any repairs to be made that the City deems necessary. This easement shall include, but is not be limited to, prohibiting the construction of structures or improvements that would impact or obstruct the intended purposes of the Facilities or restrict the ability of the Owner or the City to inspect, maintain, or repair the Facilities.

SECTION 5 FAILURE TO MAINTAIN FACILITIES

In the event the Owner fails to maintain the Facilities in good working order acceptable to the City and in accordance with the maintenance schedule incorporated in this Agreement, the City, in addition to any other remedies provided by State or City code, may, with due notice as provided in Section 6, enter the property and take whatever steps it deems necessary to return the Facilities to good working order. This provision shall not be construed to allow the City to erect any structure of a permanent nature on the property that is not included in the plans and specifications for the development, or other agreement between the parties. It is expressly understood and agreed that the City is under no obligation to maintain or repair the Facilities. The decision to maintain or repair the Facilities shall be at the City's sole discretion and in no event shall this Agreement be construed to impose any such obligation on the City or to create any liability for the City refusing to undertake such a duty.

Approved as to form:
Attorney for American Fork City

SECTION 6 NOTICE OF DEFICIENCIES

If the City finds that the Facilities contain any defects or are not being maintained adequately, the City shall provide Owner written notice of the defects or deficiencies and provide Owner with a reasonable time, as determined by the City, to cure such defects or deficiencies.

SECTION 7 RECOUPMENT OF COSTS

In the event the City performs work of any nature pursuant to the Agreement, or expends any funds in the performance of said work for labor, use of equipment, supplies, materials, and the like, the Owner shall reimburse the City within thirty (30) days of receipt thereof for all the costs incurred by the City. If not paid within the prescribed time period, the City shall be entitled to record a lien against the real property in the amount of such costs. The actions described in this section are in addition to and not in lieu of any and all legal remedies available to the City as a result of the Owner's failure to maintain the Facilities.

SECTION 8 LIMITATION OF LIABILITIES

It is the sole intent of this Agreement to insure the proper construction and maintenance of the Facilities by the Owner. As the Facilities are not part of the City's Storm Water Collection System, this agreement does not create or extend any rights to immunity or liability protections provided by law to municipalities. This Agreement shall not be deemed to create or affect any additional liability of any party for damage alleged to result from or caused by storm water runoff, or to constitute a waiver of any immunity provided to the City through the Utah State Code or Constitution.

SECTION 9 SEDIMENT ACCUMULATION

Adequate maintenance shall include control of sediment accumulation resulting from the normal operation of the Facilities. The Owner will make accommodations for the removal and appropriate disposal of all accumulated sediments.

SECTION 10 REQUIREMENTS AND STANDARDS

The Parties agree to follow and comply with all requirements applicable to storm water detention and control facilities as by the Utah Department of Environmental Quality, Division of Water Quality, including the Small MS4 General UPDES Permit requirements, and by the City ordinances and Storm Water Management Plan as existing at the time of executing this agreement and as may be amended from time to time. The parties agree that these requirements and regulations are incorporated herein by this reference and that this agreement shall be deemed

Approved as to form:
Attorney for American Fork City

automatically amended to incorporate any and all changes and amendments made thereto after the signing of this agreement.

SECTION 11 INSPECTIONS

The Owner shall perform an annual inspection of the Facilities. The City may require more frequent inspections should it have reason to believe that such inspections are necessary. All inspections shall be conducted by a qualified inspector and the results shall be reported to the City. The purpose of the inspection and reporting is to assure safe and proper functioning of the Facilities, including but not limited to, the structural improvements, berms, outlet structure, pond areas, access roads, vegetation, landscaping, etc. All annual inspection reports shall be submitted to the City Public Works Department no later than September 1 of any given year and shall be on the Maintenance Inspection Report attached hereto as Exhibit D.

SECTION 12 INDEMNITY

The Owner indemnifies and holds harmless the City and its authorized agents and employees for any and all damages, accidents, casualties, occurrences or claims which might arise or be asserted against the City from the construction, presence, existence or maintenance of the facility or facilities by the Owner. In the event a claim is asserted against the City, its authorized agents or employees, the City shall promptly notify the Owner and the Owner shall defend at its own expense any suit based on such claim. If any judgment or claims against the City, its authorized agents or employees shall be allowed, the Owner shall pay for all costs and expenses in connection herewith.

SECTION 13 COVENANT RUNNING WITH THE LAND

This Agreement shall be recorded at the Utah County Recorder's Office and shall constitute a covenant running with the land and shall be binding on the Owner, its administrators, executors, heirs, assigns and any other successors in interest, including any homeowners association.

SECTION 14 REMEDIES

This Agreement may be enforced by proceedings at law or in equity by or against the parties hereto and their respective successors in interest. Any rights or remedies contained in this Agreement shall be in addition, and non-exclusive, to any rights existing under the Utah Code or that may exist under the common law.

Approved as to form:
Attorney for American Fork City

SECTION 15
ATTORNEYS FEES

If any party retains, consults, or uses an attorney because of any breach, default, or failure to perform as required by this Agreement, the non-breaching/defaulting party shall be entitled to reasonable attorney's fees incurred before litigation is filed. In the event that any litigation is commenced to enforce or interpret this Agreement the prevailing party shall be entitled to its attorneys fees, expert witness expenses, and litigation related expenses, including but not limited to court costs.

SECTION 16
THIRD PARTY BENEFICIARIES

This Agreement shall be binding upon and inure solely to the benefit of the parties herein and is not intended to create contractual rights in any third party.

SECTION 17
NO PARTNERSHIP

Nothing contained in this Agreement shall be deemed to create any form of a partnership or joint-venture between the City and Owner.

SECTION 18
UTAH LAW AND VENUE

This Agreement shall be interpreted pursuant to the laws of the State of Utah. Any and all suits for any claims or for any and every breach or dispute arising out of this Agreement shall be maintained in the appropriate court of competent jurisdiction in Utah County, Utah.

SECTION 19
INTEGRATED AGREEMENT

This Agreement sets forth the entire agreement of the parties and supersedes all prior agreements, whether written or oral, that exists between the parties regarding the subject matter of this Agreement.

SECTION 20
SEVERABILITY

The provisions of this agreement shall be severable and if any phrase, clause, sentence or provision is declared unconstitutional, or the applicability thereof to the, its successors and assigns, is held invalid, the remainder of this Covenant shall not be affected thereby.

Approved as to form:
Attorney for American Fork City

SECTION 21
AMENDMENTS

Except as expressly provided elsewhere in this Agreement, no provision of this Agreement may not be modified except in writing agreed to by both parties.

IN WITNESS WHEREOF, the parties hereto have executed this Agreement on the dates set forth below.

OWNER

Date: October 26, 2020.
By: [Signature]
Its: (Member) Grant Lefgren
Its: Member

NOTARIZATION

STATE OF UTAH)
) :ss
COUNTY OF UTAH)

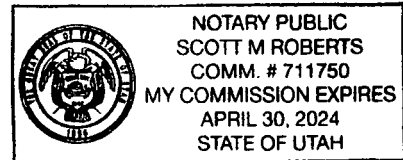

The above Agreement was executed on this 26th day of October, 2020 by Grant Lefgren, for and on behalf of RWR Property Holdings, the Owner identified in the above signed Agreement. In executing this Agreement, the signer did swear before me that he is duly authorized to sign the agreement on behalf of the Owner.

[Signature]
NOTARY PUBLIC

AMERICAN FORK CITY

Date: October 26, 2020.
[Signature]
Scott Sensanbaugher
Director of Public Works

ATTEST:

[Signature]

Approved as to form:
Attorney for American Fork City

Exhibit A

Approved as to form:
Attorney for American Fork City

EXHIBIT A

A portion of Parcel #13:040:0092

Block 5 – Phase 1 Plat

Beginning at a point being South 89°53'31" East 1,138.19 feet along section line and South 4,228.72 feet from the Northwest Corner of Section 22, Township 5 South, Range 1 East, Salt Lake Base and Meridian; and running

thence South 89°03'27" East 328.27 feet;
 thence North 00°56'33" East 56.00 feet;
 thence Northeasterly 23.56 feet along the arc of a 15.00 foot radius curve to the left (center bears North 00°56'33" East and the chord bears North 45°56'33" East 21.21 feet with a central angle of 90°00'00");
 thence South 89°03'27" East 56.00 feet;
 thence Southeasterly 23.56 feet along the arc of a 15.00 foot radius curve to the left (center bears South 89°03'27" East and the chord bears South 44°03'27" East 21.21 feet with a central angle of 90°00'00");
 thence South 89°03'27" East 140.24 feet;
 thence Northeasterly 23.50 feet along the arc of a 15.00 foot radius curve to the left (center bears North 00°56'33" East and the chord bears North 46°03'43" East 21.17 feet with a central angle of 89°45'41");
 thence North 01°10'52" East 504.52 feet;
 thence North 89°22'03" East 56.03 feet;
 thence South 01°10'52" West 430.95 feet;
 thence North 89°16'08" West 27.89 feet;
 thence South 01°14'03" West 495.65 feet;
 thence South 43°05'03" West 122.28 feet;
 thence Northwesterly 8.42 feet along the arc of a 1,000.00 foot radius curve to the left (center bears South 00°28'58" West and the chord bears North 89°45'31" West 8.42 feet with a central angle of 00°28'58");
 thence West 504.46 feet;
 thence Northwesterly 23.80 feet along the arc of a 15.00 foot radius curve to the right (center bears North and the chord bears North 44°32'57" West 21.38 feet with a central angle of 90°54'06");
 thence North 00°54'06" East 418.77 feet;
 thence Northeasterly 23.57 feet along the arc of a 15.00 foot radius curve to the right (center bears South 89°05'54" East and the chord bears North 45°55'19" East 21.22 feet with a central angle of 90°02'28") to the point of beginning.

Contains 310,177 Square Feet or 7.121 Acres and 54 Lots

Storm Water Detention Parcel

Beginning at a point being South 89°53'31" East 1,053.97 feet along section line and South 4,749.60 feet from the Northwest Corner of Section 22, Township 5 South, Range 1 East, Salt Lake Base and Meridian; and running

thence East 522.95 feet;
thence South 43°05'03" West 236.16 feet;
thence South 82°59'11" West 119.78 feet;
thence North 88°32'33" West 245.68 feet;
thence North 00°54'06" East 180.88 feet to the point of beginning.

Contains 80,214 Square Feet or 1.841 Acres

Exhibit B

Approved as to form:
Attorney for American Fork City

Long-Term Stormwater Management Plan
Rockwell Ranch Block 5 – Phase I

EXHIBIT B

Long-Term Stormwater Management Plan

for:

Rockwell Ranch Block 5 – Phase 1
1050 West 600 South
American Fork City, Utah, 84003

PURPOSE AND RESPONSIBILITY

As required by the Clean Water Act and resultant local regulations, including American Fork City Municipal Separate Storm Sewer Systems (MS4) Permit, those who develop land are required to build and maintain systems to minimize litter and contaminants in stormwater runoff that pollute waters of the State.

This Long-Term Stormwater Management Plan (LTSWMP) describes the systems, operations and the minimum standard operating procedures (SOPs) necessary to manage pollutants originating from or generated on this property. Any activities or site operations at this property that contaminate water entering the City's stormwater system and generate loose litter must be prohibited, unless SOPs are written to manage those activities or operations, and amended into this LTSWMP.

The project discharges into adjacent public streets that are routed to a detention basin with discharges into ditches and eventually finds its way to Utah Lake. Based on information provided by the Utah Department of Environmental Quality Utah Lake is identified as being impaired due to excess total phosphorus. The LTSWMP is aimed at addressing these impairments in addition to all other pollutants that can be generated by this property.

CONTENTS

SECTION 1: SITE DESCRIPTION, USE AND IMPACT
SECTION 2: TRAINING
SECTION 3: RECORDKEEPING
SECTION 4: CONTACT INFORMATION
SECTION 5: APPENDICES

SECTION 1: SITE DESCRIPTION, USE AND IMPACT

The site infrastructure at our site is limited at controlling and containing pollutants and our operations if managed improperly can contaminate the environment. This LTSWMP includes standard operations procedures (SOP)s that are intended to compensate for the pollution containment limitations of our site infrastructure and direct our maintenance operations to responsibly manage our grounds.

If or when SOPs change or are updated the city will be notified.

Parking, Sidewalk and flatwork

The site consists of private alleys, driveways, and sidewalks that tie to proposed buildings and adjacent public roadways. These hardscape surfaces if not kept property clean can impact stormwater quality.

Any sediment, leaves, debris, spilt fluids or other waste that collects on our parking lots and sidewalks will be carried by runoff to our storm drain inlets. This waste material will settle in our storm drain system increasing maintenance cost and solid and dissolved waste in our runoff can pass through our system ultimately polluting Utah Lake. Maintenance involves regular sweeping, but it can also involve pavement washing to remove stains, slick spots and improve appearance when necessary. Use our Pavement Maintenance and the Pavement Washing SOPs to manage pollutants that collect on our pavements.

Landscaping

Our landscape operations can result in grass clippings, sticks, branches, dirt, mulch, fertilizers, pesticides and other pollutants to fall or be left on our paved areas. This waste material will settle in our storm drain system increasing maintenance cost and solid and dissolved waste in our runoff can pass through our storm drain system ultimately polluting Utah Lake. The primary pollutant impairing Utah Lake is organic material so it is vital that our paved areas with direct connection to the City storm drain systems remain clean of landscape debris.

Use our Landscape Maintenance SOP to prevent this potential pollution source from affecting the Utah Lake.

Storm Drain System

The storm drain inlets direct all runoff to public streets that are eventually routed through an offsite detention basin and though a stormwater treatment unit that is designed to capture floating material and heavier sediment particles, but does not trap suspended or dissolved pollutants. This device is susceptible to bypass and scour during large storm events and the dissolved pollutants will pass through and harm Utah Lake. Also, our stormwater treatment system holds water that can breed mosquitoes. It is important to regularly maintain this system to protect Utah Lake and prevent mosquito breeding. Use our Storm Drain Maintenance SOP manage our storm drain system responsibly.

Waste Management

Each condominium unit and townhome unit within the project will have their own individual dumpster. Good waste management systems, if managed improperly, can become the source of the very pollution that they were intended to control. Use our Waste Management SOP to control and manage the solid waste we generate.

Snow and Ice Removal Management

Salt is a necessary pollutant and is vital to ensuring a safe parking and pedestrian walkways. However, the snow removal operations if improperly managed will increase our salt impact to our own vegetation and local water resources. Use our Snow and Ice Removal SOP to minimize our salt impact.

SECTION 2: TRAINING

Ensure that all employees and maintenance contractors know and understand the SOPs specifically written to manage and maintain the property. Maintenance contractors must use the stronger of their Company and the LTSWMP SOPs. File all training records in Appendix C.

SECTION 3: RECORDKEEPING

Maintain records of operation and maintenance activities in accordance with SOPs. Mail a copy of the record to American Fork City Stormwater Division annually.

SECTION 4: CONTACT INFORMATION.

HOA

Rockwell Ranch Master Owners Association, Inc.
520 South 850 East, Suite A300,
Lehi, Utah 84043.

Contact: TBD

Developer

White Horse Developers
520 South 850 East, Suite A4
Lehi, Utah 84043

Contact: Jake Horan
(801) 362-8420

SECTION 5: APPENDICES

Appendix A- Site Drawings and Details

Appendix B- SOPs

Appendix C- UniStorm System Operation and Maintenance Manual

Appendix D- Recordkeeping Documents

APPENDIX A – SITE DRAWINGS AND DETAILS

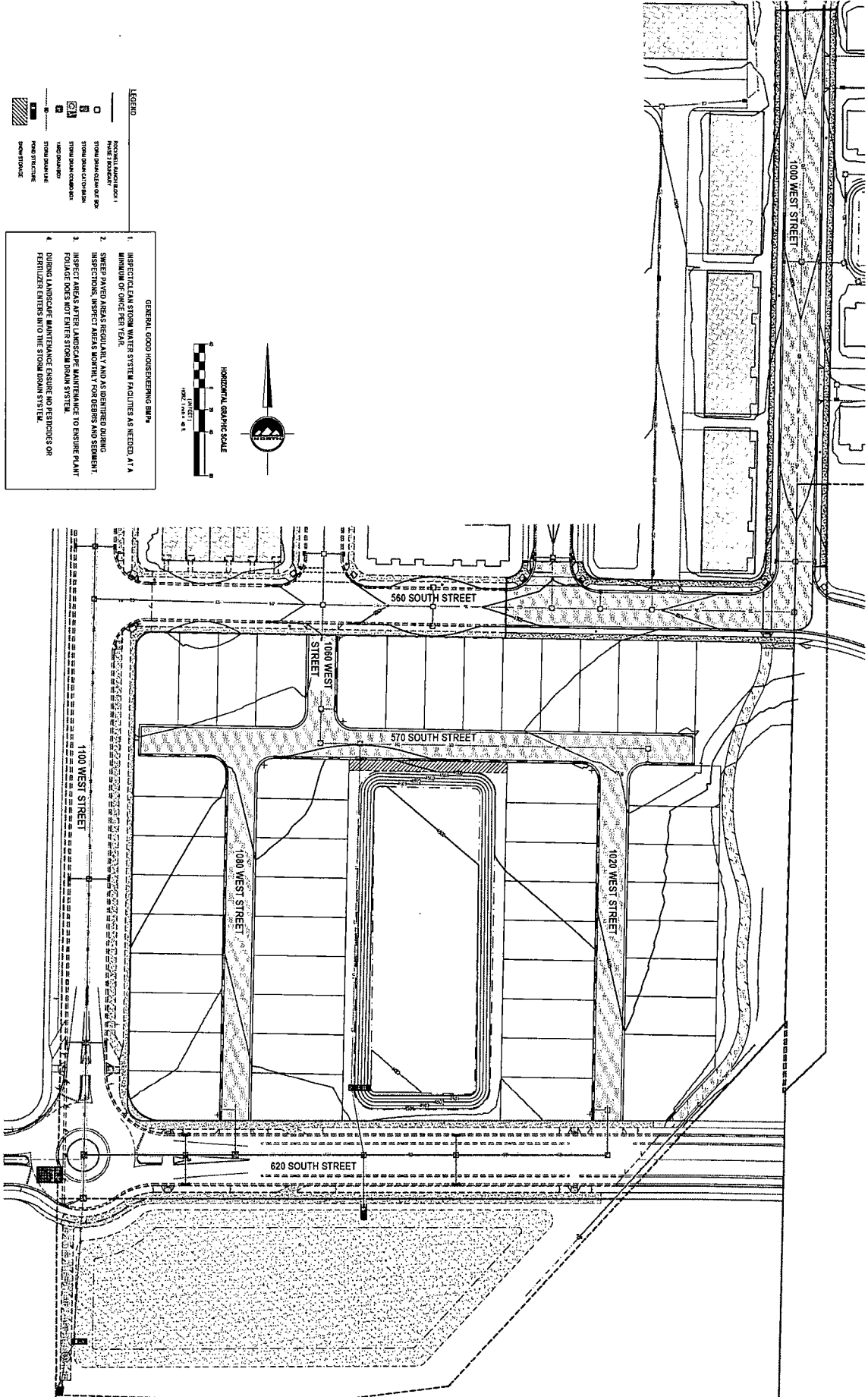

- LEGEND**
- ROAD MATERIAL BLOCK 1
 - ▨ ROAD MATERIAL BLOCK 2
 - ▧ STORM DRAIN COVER
 - ▩ STORM DRAIN COVER
 - STORM DRAIN COVER
 - ▬ STORM DRAIN LINE
 - ▭ STORM STRUCTURE
 - ▮ SLOPE INDICATOR
- GENERAL, GOOD HOUSEKEEPING BMP**
1. INSPECT CLEAN STORM WATER SYSTEM FACILITIES AS NEEDED, AT A MINIMUM OF ONCE PER YEAR.
 2. SWEEP PAVED AREAS REGULARLY AND AS IDENTIFIED DURING INSPECTIONS. INSPECT AREAS MONTHLY FOR DEBRIS AND SEDIMENT. FOLIAGE DOES NOT ENTER STORM DRAIN SYSTEM.
 3. INSPECT AREAS AFTER LANDSCAPE MAINTENANCE TO ENSURE PLANT FOLIAGE DOES NOT ENTER STORM DRAIN SYSTEM.
 4. DURING LANDSCAPE MAINTENANCE ENSURE NO RESTRICTIONS OR FERTILIZERS ENTER INTO THE STORM DRAIN SYSTEM.

<p>EX-7</p>	<p>THE SPRINGS AT ROCKWELL RANCH BLOCK 5 - PHASE 1 1050 WEST 600 SOUTH AMERICAN FORK, UTAH 84003</p>	<p>EN SIGN THE STANDARD IN ENGINEERING</p> <p>9417 LAKE CITY 43°W 100°03'S, S46°00' Phone: 801.261.0299</p> <p>LAYTON Phone: 801.341.1100</p> <p>TOOELE Phone: 435.331.3500</p> <p>CEDAR CITY Phone: 435.865.1453</p> <p>RICHFIELD Phone: 435.886.2983</p> <p>WWW.ENSIGNENGINEERING.COM</p>	<p>STORM WATER MANAGEMENT PLAN</p> <p>DATE: 02/22/21 DRAWN BY: JTB CHECKED BY: JTB</p>
--------------------	-------------------------------------------------------------------------------------------------------------------------------------------------------------------	-------------------------------------------------------------------------------------------------------------------------------------------------------------------------------------------------------------------------------------------------------------------------------------------------------------------------------------------------------------------------------------------------------------------------------------------------------	-----------------------------------------------------------------------------------------------------------------------------------------

811
CALL BEFORE YOU DIG
FOR UTILITY INFORMATION
PROVIDE TO THE OPERATOR
YOUR PROJECT NUMBER
DATE OF CALL
TYPE OF SERVICE
AND LOCATION

BENCHMARK
THE CORNER OF SECTION 22, T127
RANGE 10E, SOUTH 40TH
AND EAST 100TH
ELEVATION 5217.5

- GENERAL NOTES**
1. ALL WORK TO COMPLY WITH THE GENERAL REGULATORY STANDARDS AND SPECIFICATIONS
 2. ALL DIMENSIONS UNLESS OTHERWISE NOTED ARE IN FEET AND INCHES
 3. ALL UTILITIES SHOWN ARE BASED ON RECORD DRAWINGS AND FIELD SURVEY
 4. ALL UTILITIES TO BE LOCATED AND DEPTH TO BE DETERMINED BY THE CONTRACTOR
 5. ALL UTILITIES TO BE PROTECTED BY THE CONTRACTOR
 6. ALL UTILITIES TO BE DELETED BY THE CONTRACTOR
 7. ALL UTILITIES TO BE RELOCATED BY THE CONTRACTOR
 8. ALL UTILITIES TO BE INSTALLED BY THE CONTRACTOR
 9. ALL UTILITIES TO BE MAINTAINED BY THE CONTRACTOR
 10. ALL UTILITIES TO BE REPAIRED BY THE CONTRACTOR
 11. ALL UTILITIES TO BE REPLACED BY THE CONTRACTOR
 12. ALL UTILITIES TO BE REMOVED BY THE CONTRACTOR
 13. ALL UTILITIES TO BE ABANDONED BY THE CONTRACTOR
 14. ALL UTILITIES TO BE INSTALLED AT THE CONTRACTOR'S RISK
 15. ALL UTILITIES TO BE INSTALLED AT THE CONTRACTOR'S RISK
 16. ALL UTILITIES TO BE INSTALLED AT THE CONTRACTOR'S RISK
 17. ALL UTILITIES TO BE INSTALLED AT THE CONTRACTOR'S RISK
 18. ALL UTILITIES TO BE INSTALLED AT THE CONTRACTOR'S RISK
 19. ALL UTILITIES TO BE INSTALLED AT THE CONTRACTOR'S RISK
 20. ALL UTILITIES TO BE INSTALLED AT THE CONTRACTOR'S RISK

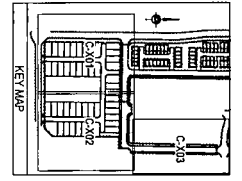
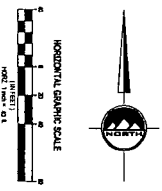
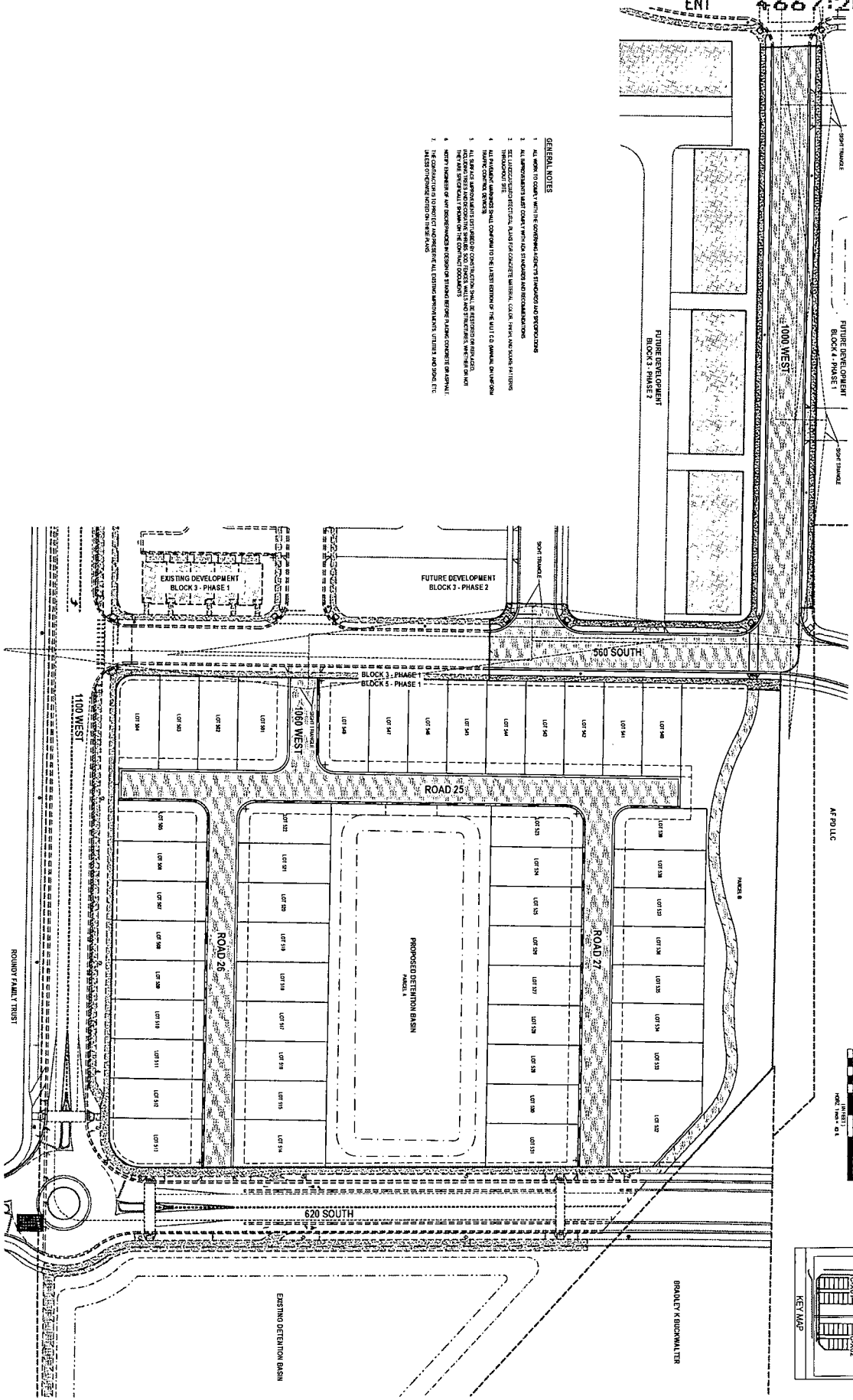

ENSIGN
THE SIMPSON ENGINEERING

SALT LAKE CITY
45 W. 1000 S. Suite 200
Salt Lake, UT 84100
Phone: 801.285.0529

LATON
Phone: 801.571.1100

TOOLE
Phone: 435.843.3590

CEGAR CITY
Phone: 435.885.1453

RICHFIELD
Phone: 435.885.2953

THE SPRINGS AT ROCKWELL RANCH
BLOCK 5 - PHASE 1
1050 WEST 600 SOUTH
AMERICAN FORK, UTAH 84003

PHONE: 801.285.0529
FAX: 801.285.0530
WWW.ENSIGNENGINEERING.COM

C-100
OVERALL SITE PLAN

DATE: 10/15/2021
SCALE: AS SHOWN
DRAWN BY: JLD
CHECKED BY: JLD



BENCHMARK
 THE BENCHMARK OF EXCELLENCE IN CONSTRUCTION
 1000 WEST 600 SOUTH
 AMERICAN FORK, UT 84003
 PH: 435.885.1433
 FAX: 435.885.1434

- GENERAL NOTES**
1. ALL WORK TO BE DONE IN ACCORDANCE WITH THE UTAH CONSTRUCTION CODE AND ALL APPLICABLE LOCAL ORDINANCES.
 2. ALL UTILITIES SHOWN ARE BASED ON RECORD DRAWINGS AND FIELD SURVEY. VERIFY ALL UTILITIES PRIOR TO CONSTRUCTION.
 3. ALL CONSTRUCTION SHALL BE IN ACCORDANCE WITH THE UTAH CONSTRUCTION CODE AND ALL APPLICABLE LOCAL ORDINANCES.
 4. ALL MATERIALS AND METHODS OF CONSTRUCTION SHALL BE APPROVED BY THE CITY ENGINEER PRIOR TO CONSTRUCTION.
 5. ALL CONSTRUCTION SHALL BE IN ACCORDANCE WITH THE UTAH CONSTRUCTION CODE AND ALL APPLICABLE LOCAL ORDINANCES.
 6. ALL CONSTRUCTION SHALL BE IN ACCORDANCE WITH THE UTAH CONSTRUCTION CODE AND ALL APPLICABLE LOCAL ORDINANCES.
 7. ALL CONSTRUCTION SHALL BE IN ACCORDANCE WITH THE UTAH CONSTRUCTION CODE AND ALL APPLICABLE LOCAL ORDINANCES.
 8. ALL CONSTRUCTION SHALL BE IN ACCORDANCE WITH THE UTAH CONSTRUCTION CODE AND ALL APPLICABLE LOCAL ORDINANCES.
 9. ALL CONSTRUCTION SHALL BE IN ACCORDANCE WITH THE UTAH CONSTRUCTION CODE AND ALL APPLICABLE LOCAL ORDINANCES.
 10. ALL CONSTRUCTION SHALL BE IN ACCORDANCE WITH THE UTAH CONSTRUCTION CODE AND ALL APPLICABLE LOCAL ORDINANCES.

- NOTES TO CONTRACTOR**
1. ALL CONSTRUCTION SHALL BE IN ACCORDANCE WITH THE UTAH CONSTRUCTION CODE AND ALL APPLICABLE LOCAL ORDINANCES.
 2. ALL CONSTRUCTION SHALL BE IN ACCORDANCE WITH THE UTAH CONSTRUCTION CODE AND ALL APPLICABLE LOCAL ORDINANCES.
 3. ALL CONSTRUCTION SHALL BE IN ACCORDANCE WITH THE UTAH CONSTRUCTION CODE AND ALL APPLICABLE LOCAL ORDINANCES.
 4. ALL CONSTRUCTION SHALL BE IN ACCORDANCE WITH THE UTAH CONSTRUCTION CODE AND ALL APPLICABLE LOCAL ORDINANCES.
 5. ALL CONSTRUCTION SHALL BE IN ACCORDANCE WITH THE UTAH CONSTRUCTION CODE AND ALL APPLICABLE LOCAL ORDINANCES.
 6. ALL CONSTRUCTION SHALL BE IN ACCORDANCE WITH THE UTAH CONSTRUCTION CODE AND ALL APPLICABLE LOCAL ORDINANCES.
 7. ALL CONSTRUCTION SHALL BE IN ACCORDANCE WITH THE UTAH CONSTRUCTION CODE AND ALL APPLICABLE LOCAL ORDINANCES.
 8. ALL CONSTRUCTION SHALL BE IN ACCORDANCE WITH THE UTAH CONSTRUCTION CODE AND ALL APPLICABLE LOCAL ORDINANCES.
 9. ALL CONSTRUCTION SHALL BE IN ACCORDANCE WITH THE UTAH CONSTRUCTION CODE AND ALL APPLICABLE LOCAL ORDINANCES.
 10. ALL CONSTRUCTION SHALL BE IN ACCORDANCE WITH THE UTAH CONSTRUCTION CODE AND ALL APPLICABLE LOCAL ORDINANCES.

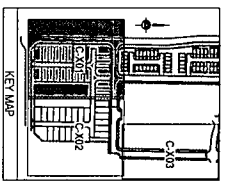
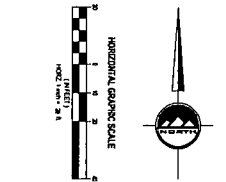
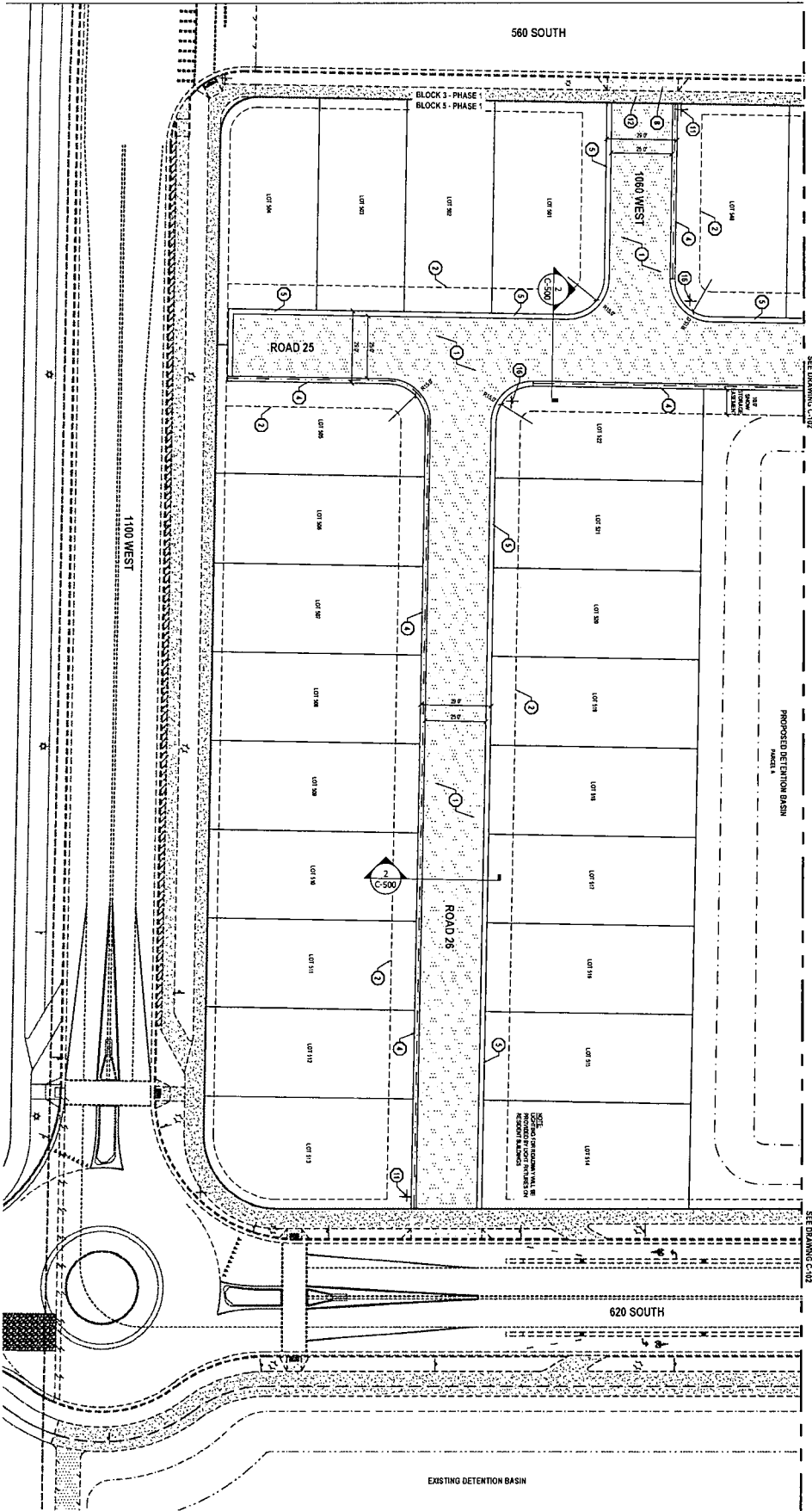

THE SPRINGS AT ROCKWELL RANCH
BLOCK 5 - PHASE 1
 1050 WEST 600 SOUTH
 AMERICAN FORK, UTAH 84003

EN SIGN
 THE STANDARD IN ENGINEERING

SALT LAKE CITY
 45 W. 1000 S., Suite 300
 Phone: 801.262.0509

LAVTON
 FROM 801.341.1100

POORIE
 FROM 801.341.1589

CEBAR CITY
 FROM 435.885.1433

RICHFIELD
 FROM 435.885.2983

C-101

SITE PLAN

DATE: 01/11/2021
 TIME: 10:00 AM
 BY: BLS
 CHECKED: BLS
 APPROVED: BLS

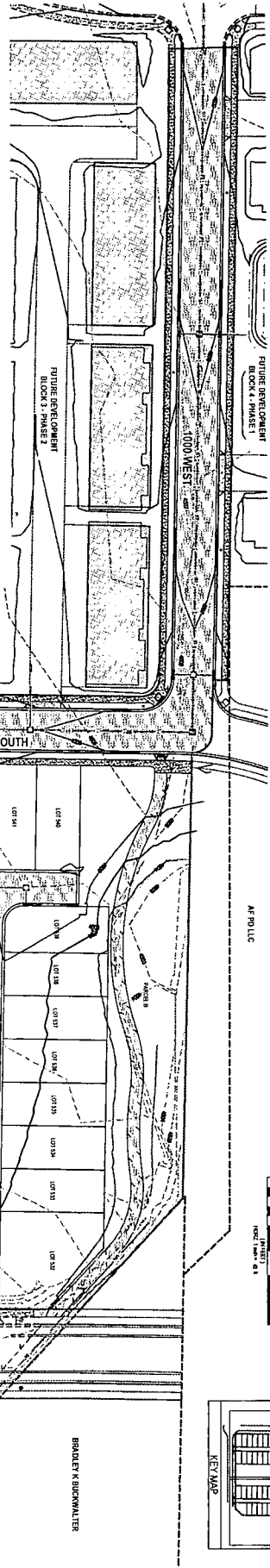

- GENERAL NOTES**
1. ALL WORK TO COMPLY WITH THE GOVERNING AGENCY'S STANDARDS AND SPECIFICATIONS.
 2. ALL UTILITIES SHALL BE DEPTH MARKED AND IDENTIFIED BY THE ENGINEER.
 3. ALL UTILITIES SHALL BE DEPTH MARKED AND IDENTIFIED BY THE ENGINEER.
 4. ALL UTILITIES SHALL BE DEPTH MARKED AND IDENTIFIED BY THE ENGINEER.
 5. ALL UTILITIES SHALL BE DEPTH MARKED AND IDENTIFIED BY THE ENGINEER.
 6. ALL UTILITIES SHALL BE DEPTH MARKED AND IDENTIFIED BY THE ENGINEER.
 7. ALL UTILITIES SHALL BE DEPTH MARKED AND IDENTIFIED BY THE ENGINEER.
 8. ALL UTILITIES SHALL BE DEPTH MARKED AND IDENTIFIED BY THE ENGINEER.
 9. ALL UTILITIES SHALL BE DEPTH MARKED AND IDENTIFIED BY THE ENGINEER.
 10. ALL UTILITIES SHALL BE DEPTH MARKED AND IDENTIFIED BY THE ENGINEER.
 11. ALL UTILITIES SHALL BE DEPTH MARKED AND IDENTIFIED BY THE ENGINEER.
 12. ALL UTILITIES SHALL BE DEPTH MARKED AND IDENTIFIED BY THE ENGINEER.
 13. ALL UTILITIES SHALL BE DEPTH MARKED AND IDENTIFIED BY THE ENGINEER.
 14. ALL UTILITIES SHALL BE DEPTH MARKED AND IDENTIFIED BY THE ENGINEER.

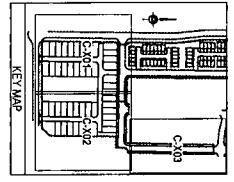
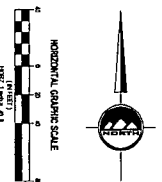
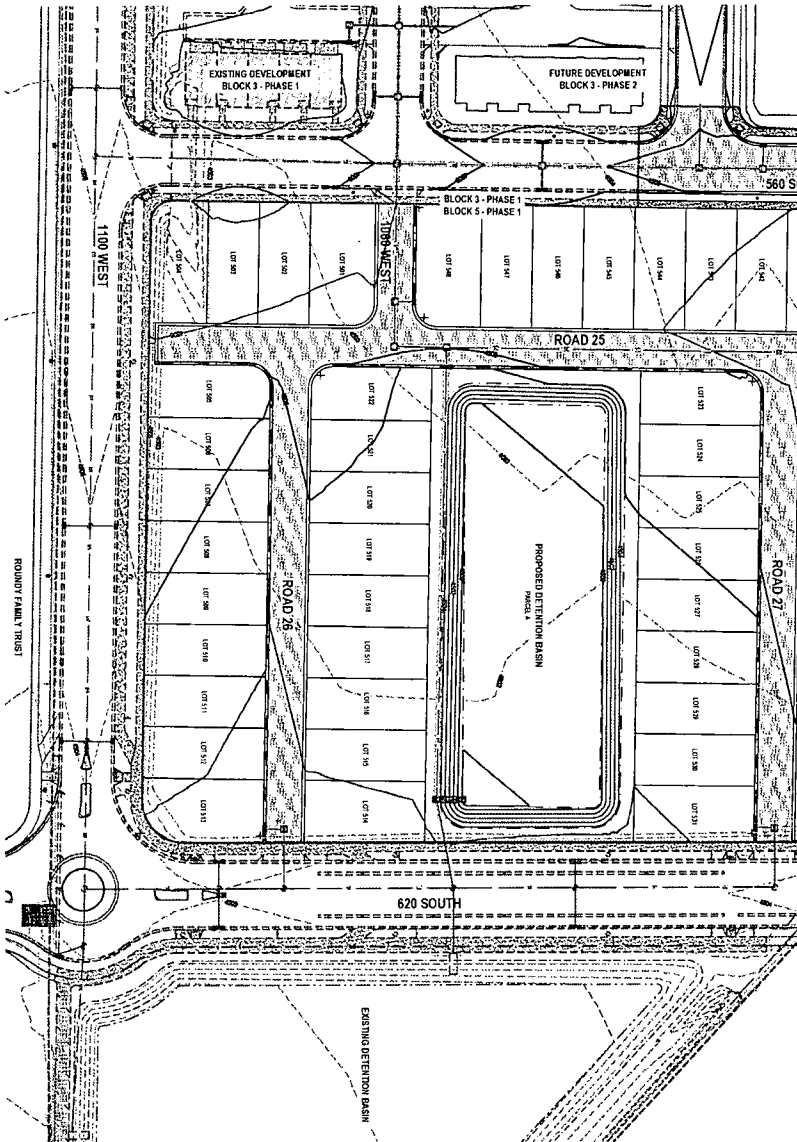

OVERALL GRADING AND DRAINAGE PLAN

DATE: 11/20/20

SCALE: 1/8" = 1'-0"

PROJECT: THE SPRINGS AT ROCKWELL RANCH

PHASE: BLOCK 5 - PHASE 1

DESIGNER: ENSIGN ENGINEERING

PROJECT NO: C-200

THE SPRINGS AT ROCKWELL RANCH
BLOCK 5 - PHASE 1
 1050 WEST 600 SOUTH
 AMERICAN FORK, UTAH 84003

ENSGN
 THE STANDARD IN ENGINEERING

SALT LAKE CITY
 65 W. 1000 S. Suite 520
 South, UT 84100
 Phone 801.251.0258

LAYTON
 Phone 801.567.1100

TOOELE
 Phone 435.843.3990

CEDAR CITY
 Phone 435.851.7453

RICHFIELD
 Phone 435.893.2983

WWW.ENSGN.COM

PROJECT NO: C-200

DATE: 11/20/20

SCALE: 1/8" = 1'-0"

PROJECT: THE SPRINGS AT ROCKWELL RANCH

PHASE: BLOCK 5 - PHASE 1

DESIGNER: ENSIGN ENGINEERING

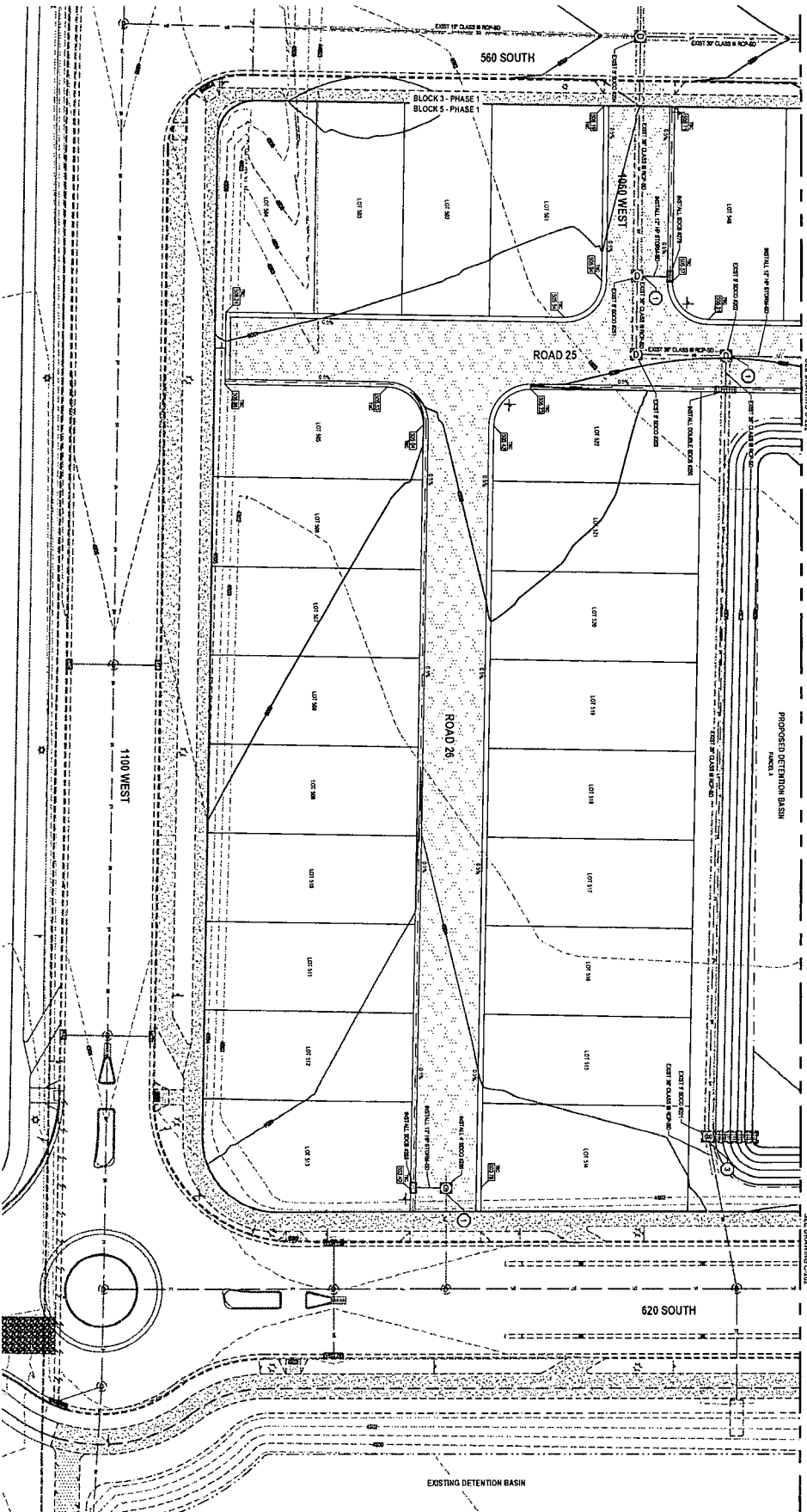

811
CALL BEFORE YOU DIG
UTAH UTILITY LOCATIONS
CONDUCTED BY
UTAH UTILITY LOCATIONS
CONTRACTORS

REQUIREMENTS
THE OWNER OF THIS PROJECT IS RESPONSIBLE FOR OBTAINING ALL NECESSARY PERMITS AND APPROVALS FROM THE APPROPRIATE AGENCIES AND AGENCIES.

- GENERAL NOTES**
1. ALL WORK SHALL BE IN ACCORDANCE WITH THE SPECIFICATIONS AND PERMITS FROM THE APPROPRIATE AGENCIES AND AGENCIES.
 2. ALL WORK SHALL BE COMPLETED WITHIN THE SPECIFIED TIME FRAME.
 3. ALL WORK SHALL BE COMPLETED WITHIN THE SPECIFIED TIME FRAME.
 4. THE CONTRACTOR SHALL BE RESPONSIBLE FOR OBTAINING ALL NECESSARY PERMITS AND APPROVALS FROM THE APPROPRIATE AGENCIES AND AGENCIES.
 5. THE CONTRACTOR SHALL BE RESPONSIBLE FOR OBTAINING ALL NECESSARY PERMITS AND APPROVALS FROM THE APPROPRIATE AGENCIES AND AGENCIES.
 6. THE CONTRACTOR SHALL BE RESPONSIBLE FOR OBTAINING ALL NECESSARY PERMITS AND APPROVALS FROM THE APPROPRIATE AGENCIES AND AGENCIES.
 7. THE CONTRACTOR SHALL BE RESPONSIBLE FOR OBTAINING ALL NECESSARY PERMITS AND APPROVALS FROM THE APPROPRIATE AGENCIES AND AGENCIES.
 8. THE CONTRACTOR SHALL BE RESPONSIBLE FOR OBTAINING ALL NECESSARY PERMITS AND APPROVALS FROM THE APPROPRIATE AGENCIES AND AGENCIES.
 9. THE CONTRACTOR SHALL BE RESPONSIBLE FOR OBTAINING ALL NECESSARY PERMITS AND APPROVALS FROM THE APPROPRIATE AGENCIES AND AGENCIES.
 10. THE CONTRACTOR SHALL BE RESPONSIBLE FOR OBTAINING ALL NECESSARY PERMITS AND APPROVALS FROM THE APPROPRIATE AGENCIES AND AGENCIES.

11. THE CONTRACTOR SHALL BE RESPONSIBLE FOR OBTAINING ALL NECESSARY PERMITS AND APPROVALS FROM THE APPROPRIATE AGENCIES AND AGENCIES.
12. THE CONTRACTOR SHALL BE RESPONSIBLE FOR OBTAINING ALL NECESSARY PERMITS AND APPROVALS FROM THE APPROPRIATE AGENCIES AND AGENCIES.
13. THE CONTRACTOR SHALL BE RESPONSIBLE FOR OBTAINING ALL NECESSARY PERMITS AND APPROVALS FROM THE APPROPRIATE AGENCIES AND AGENCIES.
14. THE CONTRACTOR SHALL BE RESPONSIBLE FOR OBTAINING ALL NECESSARY PERMITS AND APPROVALS FROM THE APPROPRIATE AGENCIES AND AGENCIES.
15. THE CONTRACTOR SHALL BE RESPONSIBLE FOR OBTAINING ALL NECESSARY PERMITS AND APPROVALS FROM THE APPROPRIATE AGENCIES AND AGENCIES.
16. THE CONTRACTOR SHALL BE RESPONSIBLE FOR OBTAINING ALL NECESSARY PERMITS AND APPROVALS FROM THE APPROPRIATE AGENCIES AND AGENCIES.
17. THE CONTRACTOR SHALL BE RESPONSIBLE FOR OBTAINING ALL NECESSARY PERMITS AND APPROVALS FROM THE APPROPRIATE AGENCIES AND AGENCIES.
18. THE CONTRACTOR SHALL BE RESPONSIBLE FOR OBTAINING ALL NECESSARY PERMITS AND APPROVALS FROM THE APPROPRIATE AGENCIES AND AGENCIES.
19. THE CONTRACTOR SHALL BE RESPONSIBLE FOR OBTAINING ALL NECESSARY PERMITS AND APPROVALS FROM THE APPROPRIATE AGENCIES AND AGENCIES.
20. THE CONTRACTOR SHALL BE RESPONSIBLE FOR OBTAINING ALL NECESSARY PERMITS AND APPROVALS FROM THE APPROPRIATE AGENCIES AND AGENCIES.

- SCOPE OF WORK:**
1. THE CONTRACTOR SHALL CONSTRUCT THE DETENTION BASIN IN ACCORDANCE WITH THE SPECIFICATIONS AND PERMITS FROM THE APPROPRIATE AGENCIES AND AGENCIES.
 2. THE CONTRACTOR SHALL CONSTRUCT THE DETENTION BASIN IN ACCORDANCE WITH THE SPECIFICATIONS AND PERMITS FROM THE APPROPRIATE AGENCIES AND AGENCIES.
 3. THE CONTRACTOR SHALL CONSTRUCT THE DETENTION BASIN IN ACCORDANCE WITH THE SPECIFICATIONS AND PERMITS FROM THE APPROPRIATE AGENCIES AND AGENCIES.
 4. THE CONTRACTOR SHALL CONSTRUCT THE DETENTION BASIN IN ACCORDANCE WITH THE SPECIFICATIONS AND PERMITS FROM THE APPROPRIATE AGENCIES AND AGENCIES.
 5. THE CONTRACTOR SHALL CONSTRUCT THE DETENTION BASIN IN ACCORDANCE WITH THE SPECIFICATIONS AND PERMITS FROM THE APPROPRIATE AGENCIES AND AGENCIES.
 6. THE CONTRACTOR SHALL CONSTRUCT THE DETENTION BASIN IN ACCORDANCE WITH THE SPECIFICATIONS AND PERMITS FROM THE APPROPRIATE AGENCIES AND AGENCIES.
 7. THE CONTRACTOR SHALL CONSTRUCT THE DETENTION BASIN IN ACCORDANCE WITH THE SPECIFICATIONS AND PERMITS FROM THE APPROPRIATE AGENCIES AND AGENCIES.
 8. THE CONTRACTOR SHALL CONSTRUCT THE DETENTION BASIN IN ACCORDANCE WITH THE SPECIFICATIONS AND PERMITS FROM THE APPROPRIATE AGENCIES AND AGENCIES.
 9. THE CONTRACTOR SHALL CONSTRUCT THE DETENTION BASIN IN ACCORDANCE WITH THE SPECIFICATIONS AND PERMITS FROM THE APPROPRIATE AGENCIES AND AGENCIES.
 10. THE CONTRACTOR SHALL CONSTRUCT THE DETENTION BASIN IN ACCORDANCE WITH THE SPECIFICATIONS AND PERMITS FROM THE APPROPRIATE AGENCIES AND AGENCIES.

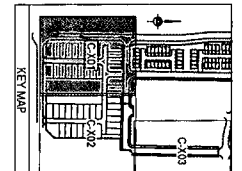
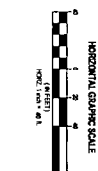

ENSIGN
THE STANDARD IN ENGINEERING

3421 LAKE CITY
SOUTH JORDAN, UT 84088
Phone: 801.460.7300
Fax: 801.460.7301

LAYTON
1000 EAST 1000 SOUTH
SALT LAKE CITY, UT 84143
Phone: 801.547.1100

TOOELE
1000 EAST 1000 SOUTH
SALT LAKE CITY, UT 84143
Phone: 435.865.1453

RICHFIELD
1000 EAST 1000 SOUTH
SALT LAKE CITY, UT 84143
Phone: 435.885.2863

WWW.ENSIGNENR.COM

DATE: 01/15/2021
DRAWN BY: J. HARRIS
CHECKED BY: J. HARRIS
SCALE: AS SHOWN

**THE SPRINGS AT ROCKWELL RANCH
BLOCK 5 - PHASE 1**
1050 WEST 600 SOUTH
AMERICAN FORK, UTAH 84003

GRADING AND DRAINAGE PLAN

DATE: 01/15/2021
DRAWN BY: J. HARRIS
CHECKED BY: J. HARRIS
SCALE: AS SHOWN

C-201

811
 CALL BEFORE YOU DIG
 Project No. 2021-0001
 Date: 01/21/2021

BENCHMARK
 In Board of Section 5, 1st
 Corner of 1000 West
 1st and 600 South
 ELEV. 4817.36'

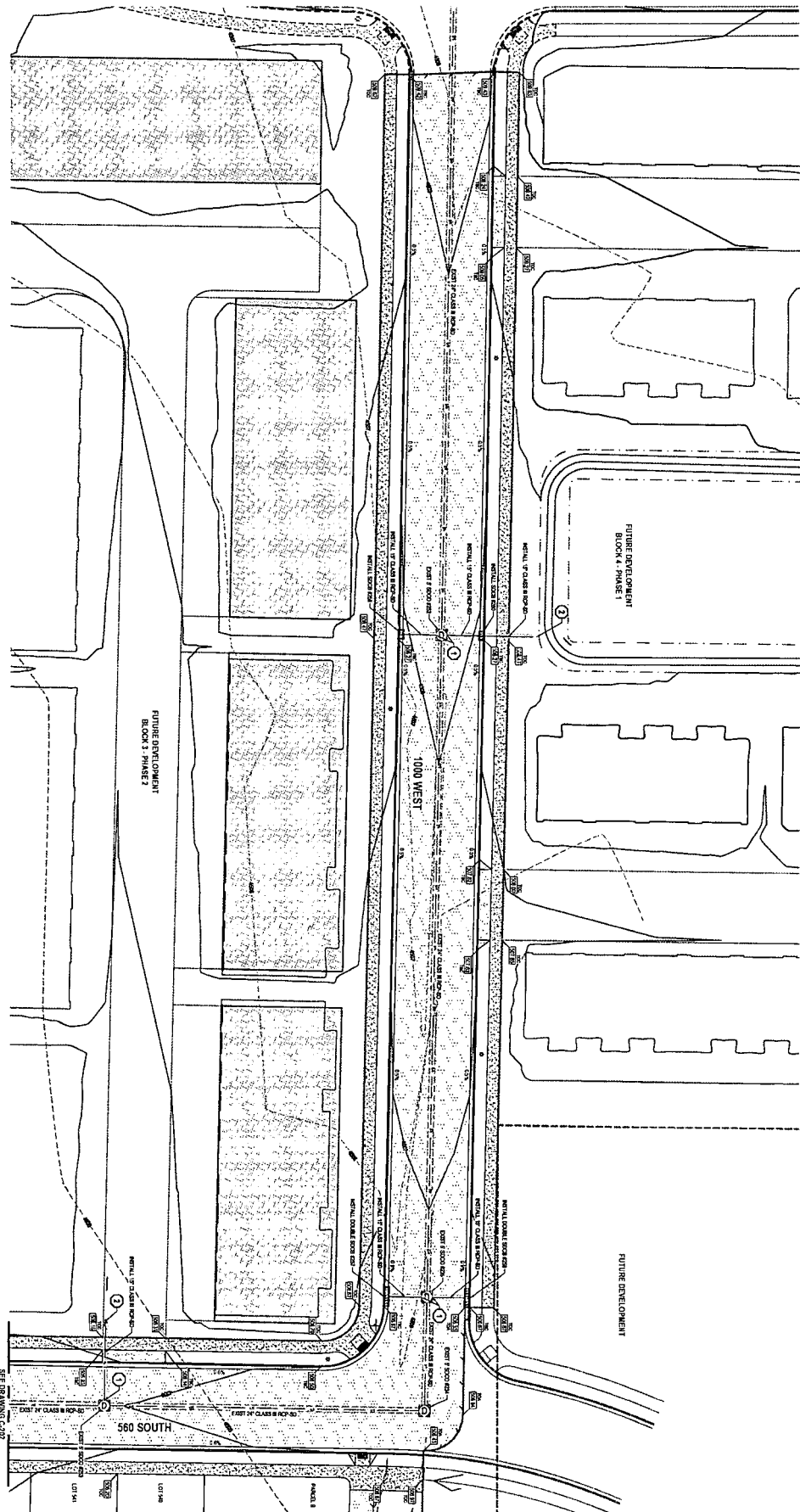

- GENERAL NOTES**
1. ALL WORK TO COMPLY WITH THE GOVERNING AGENCY'S STANDARDS AND SPECIFICATIONS.
 2. ALL SURVEYING BY COUNTY, STATE, FEDERAL OR PROFESSIONAL ENGINEER.
 3. ALL WORK SHALL COMPLY WITH THE REQUIREMENTS OF THE GEOTECHNICAL ENGINEER'S REPORT AND ANY OTHER SPECIAL REQUIREMENTS OF THE GEOTECHNICAL ENGINEER'S REPORT.
 4. THE CONTRACTOR SHALL BE RESPONSIBLE FOR OBTAINING ALL NECESSARY PERMITS AND APPROVALS FOR ALL WORK SHOWN ON THIS PLAN.
 5. ALL UTILITIES SHOWN ON THIS PLAN ARE BASED ON RECORD DRAWINGS AND FIELD SURVEYING. THE CONTRACTOR SHALL VERIFY THE LOCATION AND DEPTH OF ALL UTILITIES PRIOR TO CONSTRUCTION.
 6. ALL UTILITIES SHALL BE PROTECTED AND SHALL REMAIN IN PLACE UNLESS OTHERWISE SHOWN ON THIS PLAN.
 7. ALL UTILITIES SHALL BE DELETED UNLESS OTHERWISE SHOWN ON THIS PLAN.
 8. ALL UTILITIES SHALL BE REINSTALLED TO ORIGINAL OR BETTER CONDITIONS UNLESS OTHERWISE SHOWN ON THIS PLAN.
 9. ALL UTILITIES SHALL BE PROTECTED AND SHALL REMAIN IN PLACE UNLESS OTHERWISE SHOWN ON THIS PLAN.
 10. ALL UTILITIES SHALL BE DELETED UNLESS OTHERWISE SHOWN ON THIS PLAN.
 11. ALL UTILITIES SHALL BE REINSTALLED TO ORIGINAL OR BETTER CONDITIONS UNLESS OTHERWISE SHOWN ON THIS PLAN.
 12. THE CONTRACTOR SHALL BE RESPONSIBLE FOR OBTAINING ALL NECESSARY PERMITS AND APPROVALS FOR ALL WORK SHOWN ON THIS PLAN.
 13. ALL UTILITIES SHALL BE PROTECTED AND SHALL REMAIN IN PLACE UNLESS OTHERWISE SHOWN ON THIS PLAN.
 14. ALL UTILITIES SHALL BE DELETED UNLESS OTHERWISE SHOWN ON THIS PLAN.
 15. ALL UTILITIES SHALL BE REINSTALLED TO ORIGINAL OR BETTER CONDITIONS UNLESS OTHERWISE SHOWN ON THIS PLAN.

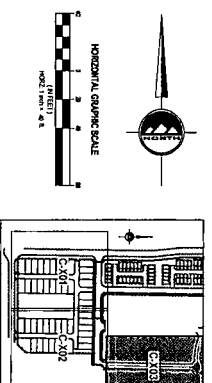

<p>C-203</p>	<p>THE SPRINGS AT ROCKWELL RANCH BLOCK 5 - PHASE 1 1050 WEST 600 SOUTH AMERICAN FORK, UTAH 84003</p>	<p>EN SIGN THE STANDARD IN ENGINEERING</p> <p>944 T LANE CITY 434 W. 1000 S. SALT LAKE CITY, UT 84103 Phone: 801.226.0292</p> <p>LAYTON Phone: 801.541.1100</p> <p>TOOELE Phone: 435.843.3599</p> <p>CEDAR CITY Phone: 435.865.1423</p> <p>RICHFIELD Phone: 435.886.2983</p>
---------------------	----------------------------------------------------------------------------------------------------------------------------------------------------------------------------	-------------------------------------------------------------------------------------------------------------------------------------------------------------------------------------------------------------------------------------------------------------------------------------------------------------------------------------------------------------------------------------------------------------------------------------------------------------

810
 QUALITY ASSURANCE
 REVIEWED BY: [Signature]
 DATE: 4-16-2021
 COMMENTS:

BENCHMARK
 THE CORNER OF 100 WEST & 100 SOUTH
 DATE: 4-16-2021
 ELEVATION: 4511.76'

- GENERAL NOTES**
1. ALL WORK SHALL BE IN ACCORDANCE WITH THE UTAH CONSTRUCTION STANDARDS AND SPECIFICATIONS.
 2. THE CONTRACTOR SHALL BE RESPONSIBLE FOR OBTAINING ALL NECESSARY PERMITS AND APPROVALS FROM THE LOCAL JURISDICTIONS.
 3. THE CONTRACTOR SHALL BE RESPONSIBLE FOR OBTAINING ALL NECESSARY PERMITS AND APPROVALS FROM THE LOCAL JURISDICTIONS.
 4. THE CONTRACTOR SHALL BE RESPONSIBLE FOR OBTAINING ALL NECESSARY PERMITS AND APPROVALS FROM THE LOCAL JURISDICTIONS.
 5. THE CONTRACTOR SHALL BE RESPONSIBLE FOR OBTAINING ALL NECESSARY PERMITS AND APPROVALS FROM THE LOCAL JURISDICTIONS.
 6. THE CONTRACTOR SHALL BE RESPONSIBLE FOR OBTAINING ALL NECESSARY PERMITS AND APPROVALS FROM THE LOCAL JURISDICTIONS.
 7. THE CONTRACTOR SHALL BE RESPONSIBLE FOR OBTAINING ALL NECESSARY PERMITS AND APPROVALS FROM THE LOCAL JURISDICTIONS.
 8. THE CONTRACTOR SHALL BE RESPONSIBLE FOR OBTAINING ALL NECESSARY PERMITS AND APPROVALS FROM THE LOCAL JURISDICTIONS.
 9. THE CONTRACTOR SHALL BE RESPONSIBLE FOR OBTAINING ALL NECESSARY PERMITS AND APPROVALS FROM THE LOCAL JURISDICTIONS.
 10. THE CONTRACTOR SHALL BE RESPONSIBLE FOR OBTAINING ALL NECESSARY PERMITS AND APPROVALS FROM THE LOCAL JURISDICTIONS.
 11. THE CONTRACTOR SHALL BE RESPONSIBLE FOR OBTAINING ALL NECESSARY PERMITS AND APPROVALS FROM THE LOCAL JURISDICTIONS.
 12. THE CONTRACTOR SHALL BE RESPONSIBLE FOR OBTAINING ALL NECESSARY PERMITS AND APPROVALS FROM THE LOCAL JURISDICTIONS.

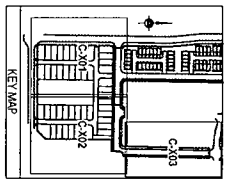
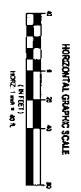
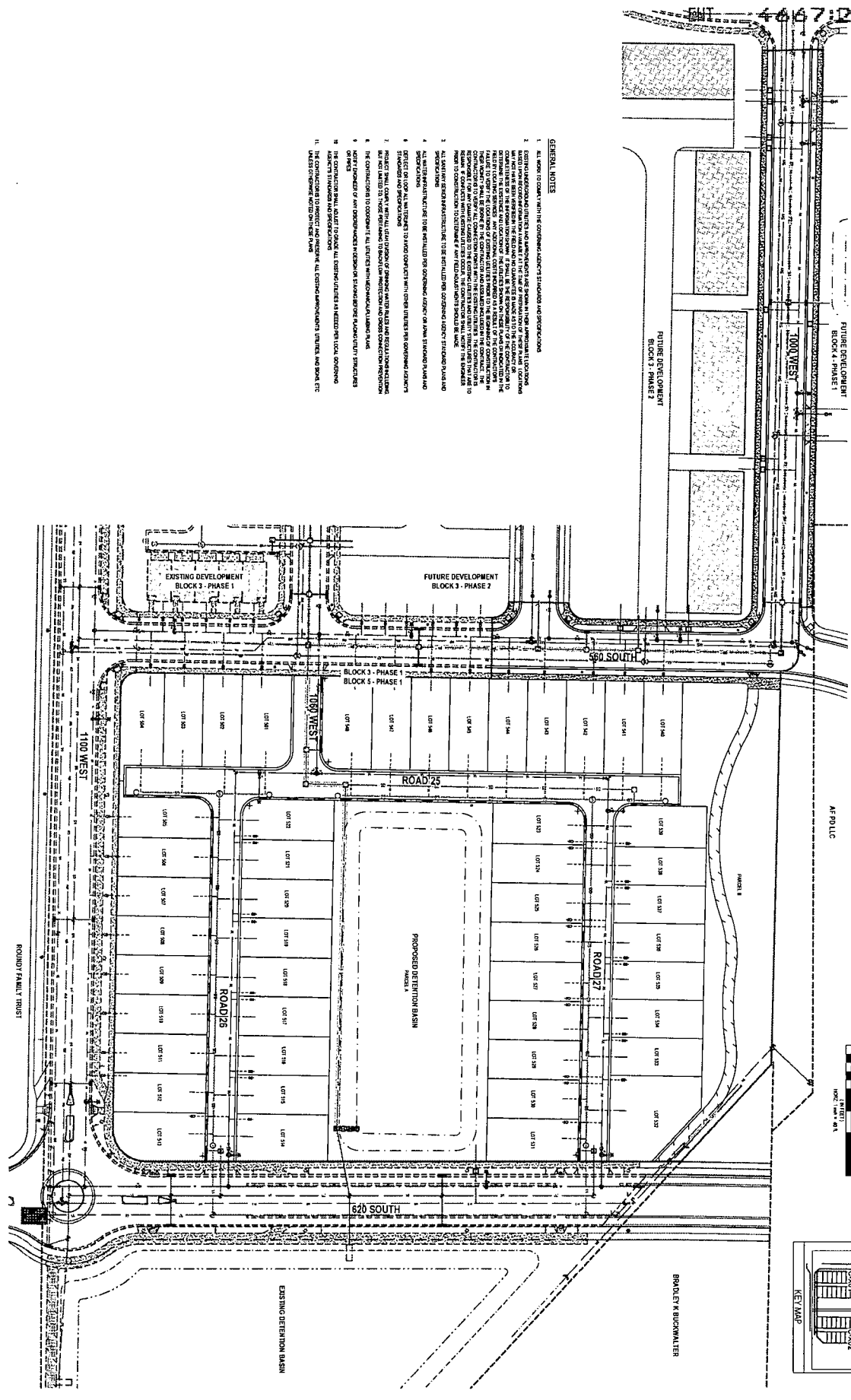

**THE SPRINGS AT ROCKWELL RANCH
 BLOCK 5 - PHASE 1
 1050 WEST 600 SOUTH
 AMERICAN FORK, UTAH 84003**

ENSIGN
 THE STANDARD IN ENGINEERING
 9411 LANE CITY
 4511 1000 S
 SALT LAKE CITY, UT 84143
 Phone: 801.255.0578
 FAX: 801.255.0578
 LAYTON
 4511 1000 S
 SALT LAKE CITY, UT 84143
 Phone: 801.255.0578
 TOOELE
 4511 1000 S
 SALT LAKE CITY, UT 84143
 Phone: 801.255.0578
 CEDAR CITY
 4511 1000 S
 SALT LAKE CITY, UT 84143
 Phone: 801.255.0578
 RICHFIELD
 4511 1000 S
 SALT LAKE CITY, UT 84143
 Phone: 801.255.0578



OVERALL UTILITY PLAN

DATE: 4-16-2021
 DRAWN BY: [Name]
 CHECKED BY: [Name]
 PROJECT NO: C-300

811
 CALL BEFORE YOU DIG
 800-4-A-SHIELD
 800-477-7243
 www.811.com

BENCHMARK
 THE CENTER OF SECTION IS LEFT
 FROM THE
 EAST AND WEST AND
 NORTH AND SOUTH
 ELEVATION

- GENERAL NOTES**
1. ALL WORK TO COMPLY WITH THE GOVERNING AGENCIES STANDARDS AND REGULATIONS
 2. EXISTING UTILITIES ARE SHOWN AS THEY EXIST. THE CONTRACTOR SHALL VERIFY THE LOCATION AND DEPTH OF ALL UTILITIES PRIOR TO CONSTRUCTION. ANY CHANGES TO THE EXISTING UTILITIES SHALL BE SHOWN ON A REVISION.
 3. THE CONTRACTOR SHALL BE RESPONSIBLE FOR OBTAINING ALL NECESSARY PERMITS AND APPROVALS FROM THE GOVERNING AGENCIES PRIOR TO CONSTRUCTION.
 4. THE CONTRACTOR SHALL BE RESPONSIBLE FOR OBTAINING ALL NECESSARY PERMITS AND APPROVALS FROM THE GOVERNING AGENCIES PRIOR TO CONSTRUCTION.
 5. ALL UTILITIES SHALL BE PROTECTED AND SHALL NOT BE INTERRUPTED DURING CONSTRUCTION.
 6. THE CONTRACTOR SHALL BE RESPONSIBLE FOR OBTAINING ALL NECESSARY PERMITS AND APPROVALS FROM THE GOVERNING AGENCIES PRIOR TO CONSTRUCTION.
 7. THE CONTRACTOR SHALL BE RESPONSIBLE FOR OBTAINING ALL NECESSARY PERMITS AND APPROVALS FROM THE GOVERNING AGENCIES PRIOR TO CONSTRUCTION.
 8. THE CONTRACTOR SHALL BE RESPONSIBLE FOR OBTAINING ALL NECESSARY PERMITS AND APPROVALS FROM THE GOVERNING AGENCIES PRIOR TO CONSTRUCTION.
 9. THE CONTRACTOR SHALL BE RESPONSIBLE FOR OBTAINING ALL NECESSARY PERMITS AND APPROVALS FROM THE GOVERNING AGENCIES PRIOR TO CONSTRUCTION.
 10. THE CONTRACTOR SHALL BE RESPONSIBLE FOR OBTAINING ALL NECESSARY PERMITS AND APPROVALS FROM THE GOVERNING AGENCIES PRIOR TO CONSTRUCTION.
 11. THE CONTRACTOR SHALL BE RESPONSIBLE FOR OBTAINING ALL NECESSARY PERMITS AND APPROVALS FROM THE GOVERNING AGENCIES PRIOR TO CONSTRUCTION.
 12. THE CONTRACTOR SHALL BE RESPONSIBLE FOR OBTAINING ALL NECESSARY PERMITS AND APPROVALS FROM THE GOVERNING AGENCIES PRIOR TO CONSTRUCTION.
 13. THE CONTRACTOR SHALL BE RESPONSIBLE FOR OBTAINING ALL NECESSARY PERMITS AND APPROVALS FROM THE GOVERNING AGENCIES PRIOR TO CONSTRUCTION.
 14. THE CONTRACTOR SHALL BE RESPONSIBLE FOR OBTAINING ALL NECESSARY PERMITS AND APPROVALS FROM THE GOVERNING AGENCIES PRIOR TO CONSTRUCTION.
 15. THE CONTRACTOR SHALL BE RESPONSIBLE FOR OBTAINING ALL NECESSARY PERMITS AND APPROVALS FROM THE GOVERNING AGENCIES PRIOR TO CONSTRUCTION.
 16. THE CONTRACTOR SHALL BE RESPONSIBLE FOR OBTAINING ALL NECESSARY PERMITS AND APPROVALS FROM THE GOVERNING AGENCIES PRIOR TO CONSTRUCTION.
 17. THE CONTRACTOR SHALL BE RESPONSIBLE FOR OBTAINING ALL NECESSARY PERMITS AND APPROVALS FROM THE GOVERNING AGENCIES PRIOR TO CONSTRUCTION.
 18. THE CONTRACTOR SHALL BE RESPONSIBLE FOR OBTAINING ALL NECESSARY PERMITS AND APPROVALS FROM THE GOVERNING AGENCIES PRIOR TO CONSTRUCTION.
 19. THE CONTRACTOR SHALL BE RESPONSIBLE FOR OBTAINING ALL NECESSARY PERMITS AND APPROVALS FROM THE GOVERNING AGENCIES PRIOR TO CONSTRUCTION.
 20. THE CONTRACTOR SHALL BE RESPONSIBLE FOR OBTAINING ALL NECESSARY PERMITS AND APPROVALS FROM THE GOVERNING AGENCIES PRIOR TO CONSTRUCTION.
- SCOPE OF WORK:**
1. PROVIDE ALL NECESSARY UTILITIES AND CONNECTIONS TO THE PROPOSED DETENTION BASIN.
 2. PROVIDE ALL NECESSARY UTILITIES AND CONNECTIONS TO THE PROPOSED DETENTION BASIN.
 3. PROVIDE ALL NECESSARY UTILITIES AND CONNECTIONS TO THE PROPOSED DETENTION BASIN.
 4. PROVIDE ALL NECESSARY UTILITIES AND CONNECTIONS TO THE PROPOSED DETENTION BASIN.
 5. PROVIDE ALL NECESSARY UTILITIES AND CONNECTIONS TO THE PROPOSED DETENTION BASIN.
 6. PROVIDE ALL NECESSARY UTILITIES AND CONNECTIONS TO THE PROPOSED DETENTION BASIN.
 7. PROVIDE ALL NECESSARY UTILITIES AND CONNECTIONS TO THE PROPOSED DETENTION BASIN.
 8. PROVIDE ALL NECESSARY UTILITIES AND CONNECTIONS TO THE PROPOSED DETENTION BASIN.
 9. PROVIDE ALL NECESSARY UTILITIES AND CONNECTIONS TO THE PROPOSED DETENTION BASIN.
 10. PROVIDE ALL NECESSARY UTILITIES AND CONNECTIONS TO THE PROPOSED DETENTION BASIN.
 11. PROVIDE ALL NECESSARY UTILITIES AND CONNECTIONS TO THE PROPOSED DETENTION BASIN.
 12. PROVIDE ALL NECESSARY UTILITIES AND CONNECTIONS TO THE PROPOSED DETENTION BASIN.
 13. PROVIDE ALL NECESSARY UTILITIES AND CONNECTIONS TO THE PROPOSED DETENTION BASIN.
 14. PROVIDE ALL NECESSARY UTILITIES AND CONNECTIONS TO THE PROPOSED DETENTION BASIN.
 15. PROVIDE ALL NECESSARY UTILITIES AND CONNECTIONS TO THE PROPOSED DETENTION BASIN.
 16. PROVIDE ALL NECESSARY UTILITIES AND CONNECTIONS TO THE PROPOSED DETENTION BASIN.
 17. PROVIDE ALL NECESSARY UTILITIES AND CONNECTIONS TO THE PROPOSED DETENTION BASIN.
 18. PROVIDE ALL NECESSARY UTILITIES AND CONNECTIONS TO THE PROPOSED DETENTION BASIN.
 19. PROVIDE ALL NECESSARY UTILITIES AND CONNECTIONS TO THE PROPOSED DETENTION BASIN.
 20. PROVIDE ALL NECESSARY UTILITIES AND CONNECTIONS TO THE PROPOSED DETENTION BASIN.

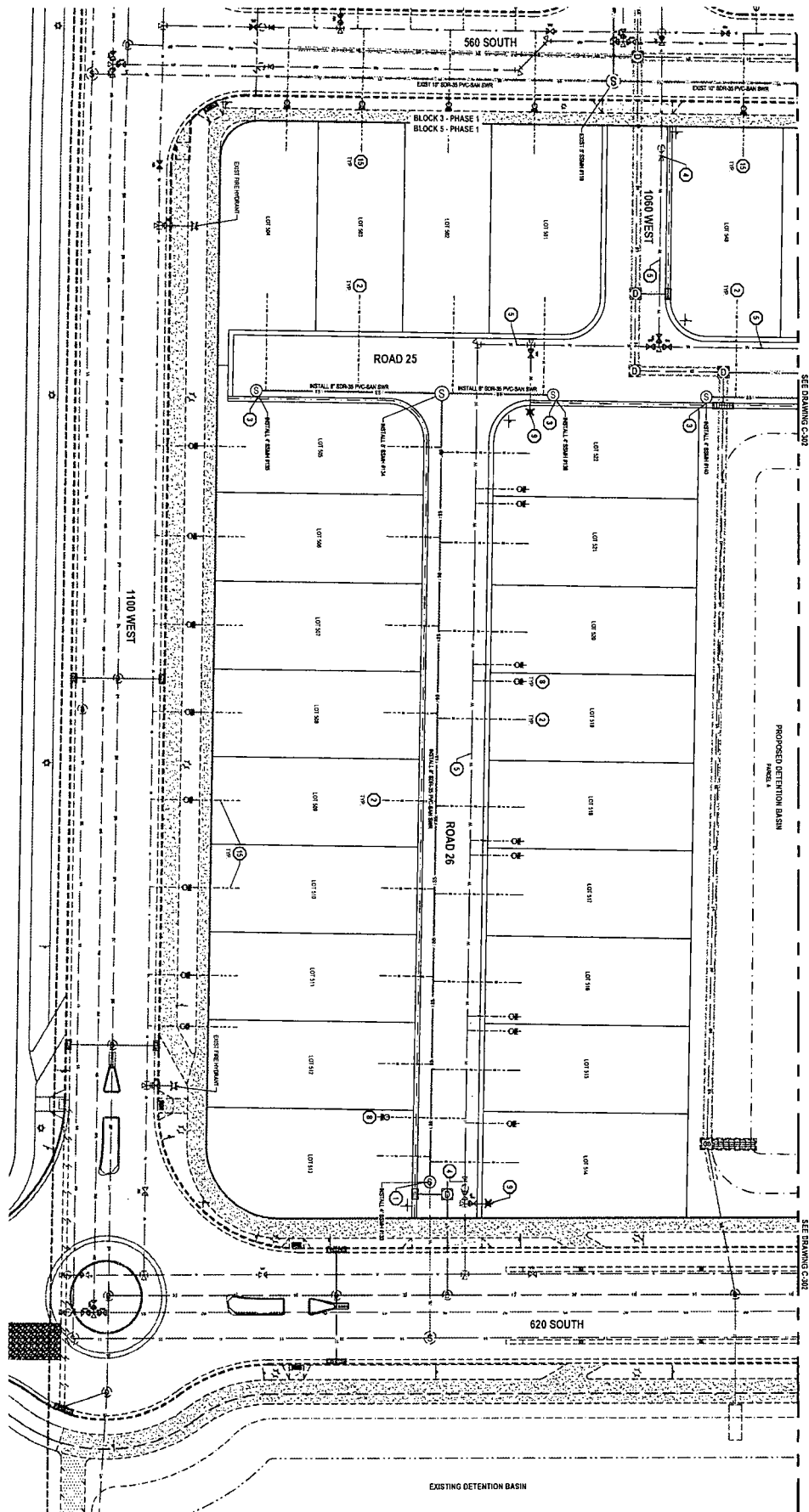

GRAPHIC SCALE
 1" = 100'

KEY MAP

C-301

THE SPRINGS AT ROCKWELL RANCH
BLOCK 5 - PHASE 1
 1050 WEST 600 SOUTH
 AMERICAN FORK, UTAH 84003

ENSGN
 THE SHIMODAIRI ENGINEERING
 501 LANE CITY
 4th - 1000 S. Main St
 Sandy, UT 84070
 Phone: 801.755.0929

LAYTON
 Phone: 801.571.1100

TOOELE
 Phone: 435.843.3590

CEDAR CITY
 Phone: 435.895.1453

RICHTFIELD
 Phone: 435.880.2980

WWW.ENSGNENGINEERING.COM

UTILITY PLAN

C-301

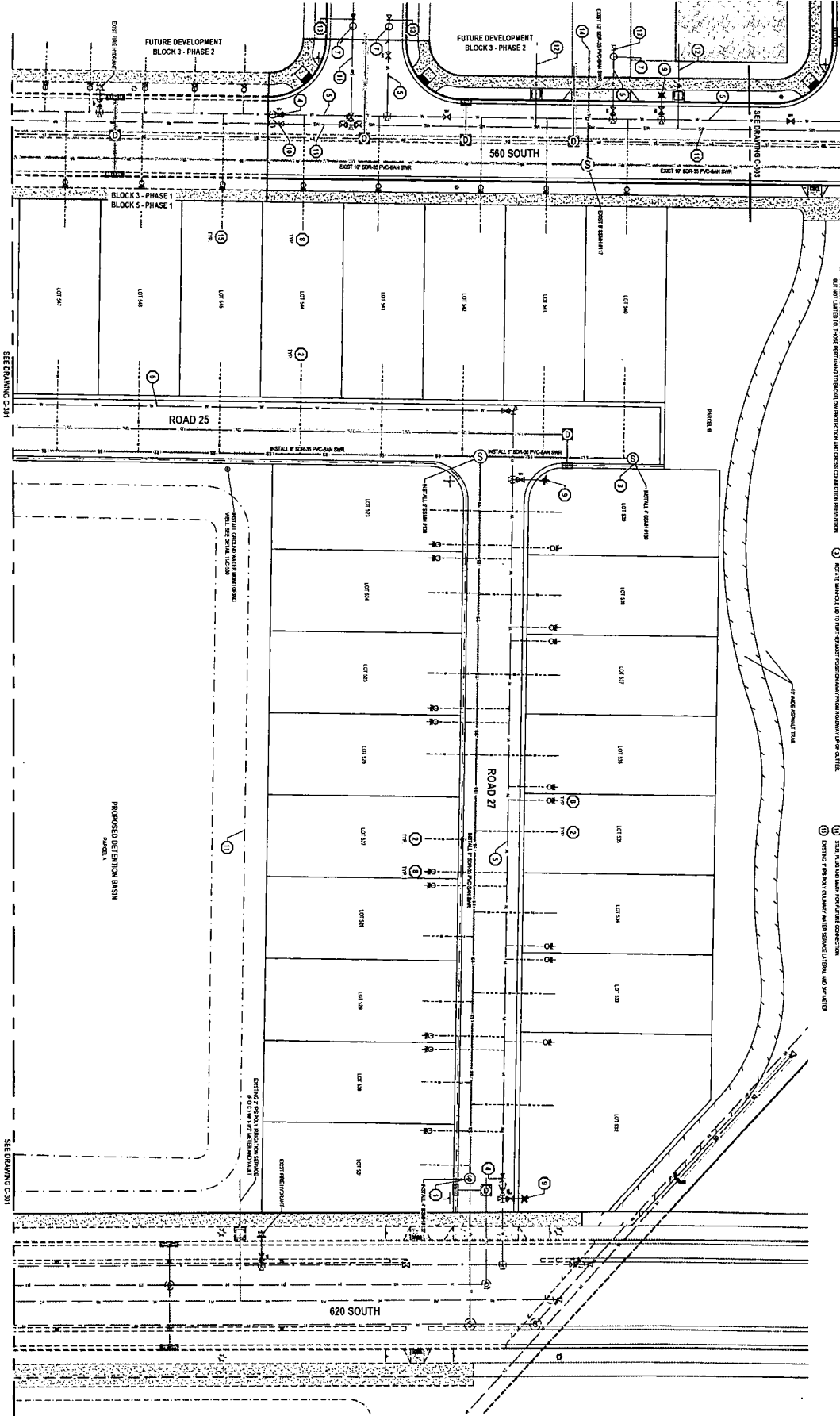

GENERAL NOTES

- 1. ALL WORK TO COMPLY WITH THE GOVERNING AGENCY STANDARDS AND SPECIFICATIONS.
- 2. EXISTING CONDITIONS OF UTILITIES AND IMPROVEMENTS ARE SHOWN IN GREEN. UNLESS OTHERWISE NOTED, ALL UTILITIES ARE SHOWN IN THE PLAN TO BE IN ACCORDANCE WITH THE CITY OF SALT LAKE COUNTY STANDARD SPECIFICATIONS FOR UTILITIES. ALL UTILITIES SHALL BE PROTECTED OR RELOCATED AS NECESSARY TO ACCOMMODATE THE PROPOSED WORK.
- 3. ALL UTILITIES SHALL BE PROTECTED OR RELOCATED AS NECESSARY TO ACCOMMODATE THE PROPOSED WORK.
- 4. ALL UTILITIES SHALL BE PROTECTED OR RELOCATED AS NECESSARY TO ACCOMMODATE THE PROPOSED WORK.
- 5. ALL UTILITIES SHALL BE PROTECTED OR RELOCATED AS NECESSARY TO ACCOMMODATE THE PROPOSED WORK.
- 6. ALL UTILITIES SHALL BE PROTECTED OR RELOCATED AS NECESSARY TO ACCOMMODATE THE PROPOSED WORK.

BENCHMARK

THE CORNER OF SECTION 22, T42N, R41E AND WEST 600 SOUTH IS THE BENCHMARK POINT FOR THIS PROJECT. THE ELEVATION OF THIS POINT IS 4287.25 FEET.

- 1. THE CONSTRUCTION SHALL COMPLY WITH THE CITY OF SALT LAKE COUNTY STANDARD SPECIFICATIONS FOR UTILITIES. ALL UTILITIES SHALL BE PROTECTED OR RELOCATED AS NECESSARY TO ACCOMMODATE THE PROPOSED WORK.
- 2. THE CONSTRUCTION SHALL COMPLY WITH THE CITY OF SALT LAKE COUNTY STANDARD SPECIFICATIONS FOR UTILITIES. ALL UTILITIES SHALL BE PROTECTED OR RELOCATED AS NECESSARY TO ACCOMMODATE THE PROPOSED WORK.
- 3. THE CONSTRUCTION SHALL COMPLY WITH THE CITY OF SALT LAKE COUNTY STANDARD SPECIFICATIONS FOR UTILITIES. ALL UTILITIES SHALL BE PROTECTED OR RELOCATED AS NECESSARY TO ACCOMMODATE THE PROPOSED WORK.
- 4. THE CONSTRUCTION SHALL COMPLY WITH THE CITY OF SALT LAKE COUNTY STANDARD SPECIFICATIONS FOR UTILITIES. ALL UTILITIES SHALL BE PROTECTED OR RELOCATED AS NECESSARY TO ACCOMMODATE THE PROPOSED WORK.
- 5. THE CONSTRUCTION SHALL COMPLY WITH THE CITY OF SALT LAKE COUNTY STANDARD SPECIFICATIONS FOR UTILITIES. ALL UTILITIES SHALL BE PROTECTED OR RELOCATED AS NECESSARY TO ACCOMMODATE THE PROPOSED WORK.
- 6. THE CONSTRUCTION SHALL COMPLY WITH THE CITY OF SALT LAKE COUNTY STANDARD SPECIFICATIONS FOR UTILITIES. ALL UTILITIES SHALL BE PROTECTED OR RELOCATED AS NECESSARY TO ACCOMMODATE THE PROPOSED WORK.

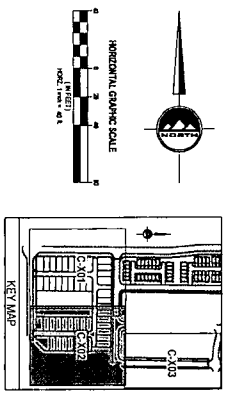

ENSIGN
SALT LAKE CITY
410 W. 1000 S. Suite 400
Stuy. UT 84107
Phone 801.255.0529

THE SPRINGS AT ROCKWELL RANCH
BLOCK 5 - PHASE 1
1050 WEST 600 SOUTH
AMERICAN FORK, UTAH 84003

UTILITY PLAN

C-302



BENCHMARK
 THE OWNER OF THIS PROJECT HAS PROVIDED THE BENCHMARK DATA FOR THIS PROJECT. THE BENCHMARK DATA IS TO BE USED TO LOCATE THE BENCHMARK POINTS AND TO BE USED TO LOCATE THE BENCHMARK POINTS IN THE FIELD. THE BENCHMARK DATA IS TO BE USED TO LOCATE THE BENCHMARK POINTS AND TO BE USED TO LOCATE THE BENCHMARK POINTS IN THE FIELD.

- GENERAL NOTES**
1. ALL WORK TO COMPLY WITH THE GOVERNMENT AGENCY STANDARDS AND SPECIFICATIONS.
 2. CONSTRUCTION SHALL BE IN ACCORDANCE WITH THE SPECIFICATIONS AND STANDARDS OF THE GOVERNMENT AGENCY STANDARDS AND SPECIFICATIONS.
 3. ALL MATERIALS AND METHODS OF CONSTRUCTION SHALL BE APPROVED BY THE GOVERNMENT AGENCY STANDARDS AND SPECIFICATIONS.
 4. ALL MATERIALS AND METHODS OF CONSTRUCTION SHALL BE APPROVED BY THE GOVERNMENT AGENCY STANDARDS AND SPECIFICATIONS.
 5. ALL MATERIALS AND METHODS OF CONSTRUCTION SHALL BE APPROVED BY THE GOVERNMENT AGENCY STANDARDS AND SPECIFICATIONS.
 6. ALL MATERIALS AND METHODS OF CONSTRUCTION SHALL BE APPROVED BY THE GOVERNMENT AGENCY STANDARDS AND SPECIFICATIONS.
 7. ALL MATERIALS AND METHODS OF CONSTRUCTION SHALL BE APPROVED BY THE GOVERNMENT AGENCY STANDARDS AND SPECIFICATIONS.
 8. ALL MATERIALS AND METHODS OF CONSTRUCTION SHALL BE APPROVED BY THE GOVERNMENT AGENCY STANDARDS AND SPECIFICATIONS.
 9. ALL MATERIALS AND METHODS OF CONSTRUCTION SHALL BE APPROVED BY THE GOVERNMENT AGENCY STANDARDS AND SPECIFICATIONS.
 10. ALL MATERIALS AND METHODS OF CONSTRUCTION SHALL BE APPROVED BY THE GOVERNMENT AGENCY STANDARDS AND SPECIFICATIONS.
 11. ALL MATERIALS AND METHODS OF CONSTRUCTION SHALL BE APPROVED BY THE GOVERNMENT AGENCY STANDARDS AND SPECIFICATIONS.
 12. ALL MATERIALS AND METHODS OF CONSTRUCTION SHALL BE APPROVED BY THE GOVERNMENT AGENCY STANDARDS AND SPECIFICATIONS.

- SCOPE OF WORK:**
1. CONSTRUCT TO COMPLETE ALL UTILITIES AND CONDUITS TO THE PROPERTY.
 2. CONSTRUCT TO COMPLETE ALL UTILITIES AND CONDUITS TO THE PROPERTY.
 3. CONSTRUCT TO COMPLETE ALL UTILITIES AND CONDUITS TO THE PROPERTY.
 4. CONSTRUCT TO COMPLETE ALL UTILITIES AND CONDUITS TO THE PROPERTY.
 5. CONSTRUCT TO COMPLETE ALL UTILITIES AND CONDUITS TO THE PROPERTY.
 6. CONSTRUCT TO COMPLETE ALL UTILITIES AND CONDUITS TO THE PROPERTY.
 7. CONSTRUCT TO COMPLETE ALL UTILITIES AND CONDUITS TO THE PROPERTY.
 8. CONSTRUCT TO COMPLETE ALL UTILITIES AND CONDUITS TO THE PROPERTY.
 9. CONSTRUCT TO COMPLETE ALL UTILITIES AND CONDUITS TO THE PROPERTY.
 10. CONSTRUCT TO COMPLETE ALL UTILITIES AND CONDUITS TO THE PROPERTY.
 11. CONSTRUCT TO COMPLETE ALL UTILITIES AND CONDUITS TO THE PROPERTY.
 12. CONSTRUCT TO COMPLETE ALL UTILITIES AND CONDUITS TO THE PROPERTY.

1. CONSTRUCT TO COMPLETE ALL UTILITIES AND CONDUITS TO THE PROPERTY.
2. CONSTRUCT TO COMPLETE ALL UTILITIES AND CONDUITS TO THE PROPERTY.
3. CONSTRUCT TO COMPLETE ALL UTILITIES AND CONDUITS TO THE PROPERTY.
4. CONSTRUCT TO COMPLETE ALL UTILITIES AND CONDUITS TO THE PROPERTY.
5. CONSTRUCT TO COMPLETE ALL UTILITIES AND CONDUITS TO THE PROPERTY.
6. CONSTRUCT TO COMPLETE ALL UTILITIES AND CONDUITS TO THE PROPERTY.
7. CONSTRUCT TO COMPLETE ALL UTILITIES AND CONDUITS TO THE PROPERTY.
8. CONSTRUCT TO COMPLETE ALL UTILITIES AND CONDUITS TO THE PROPERTY.
9. CONSTRUCT TO COMPLETE ALL UTILITIES AND CONDUITS TO THE PROPERTY.
10. CONSTRUCT TO COMPLETE ALL UTILITIES AND CONDUITS TO THE PROPERTY.
11. CONSTRUCT TO COMPLETE ALL UTILITIES AND CONDUITS TO THE PROPERTY.
12. CONSTRUCT TO COMPLETE ALL UTILITIES AND CONDUITS TO THE PROPERTY.

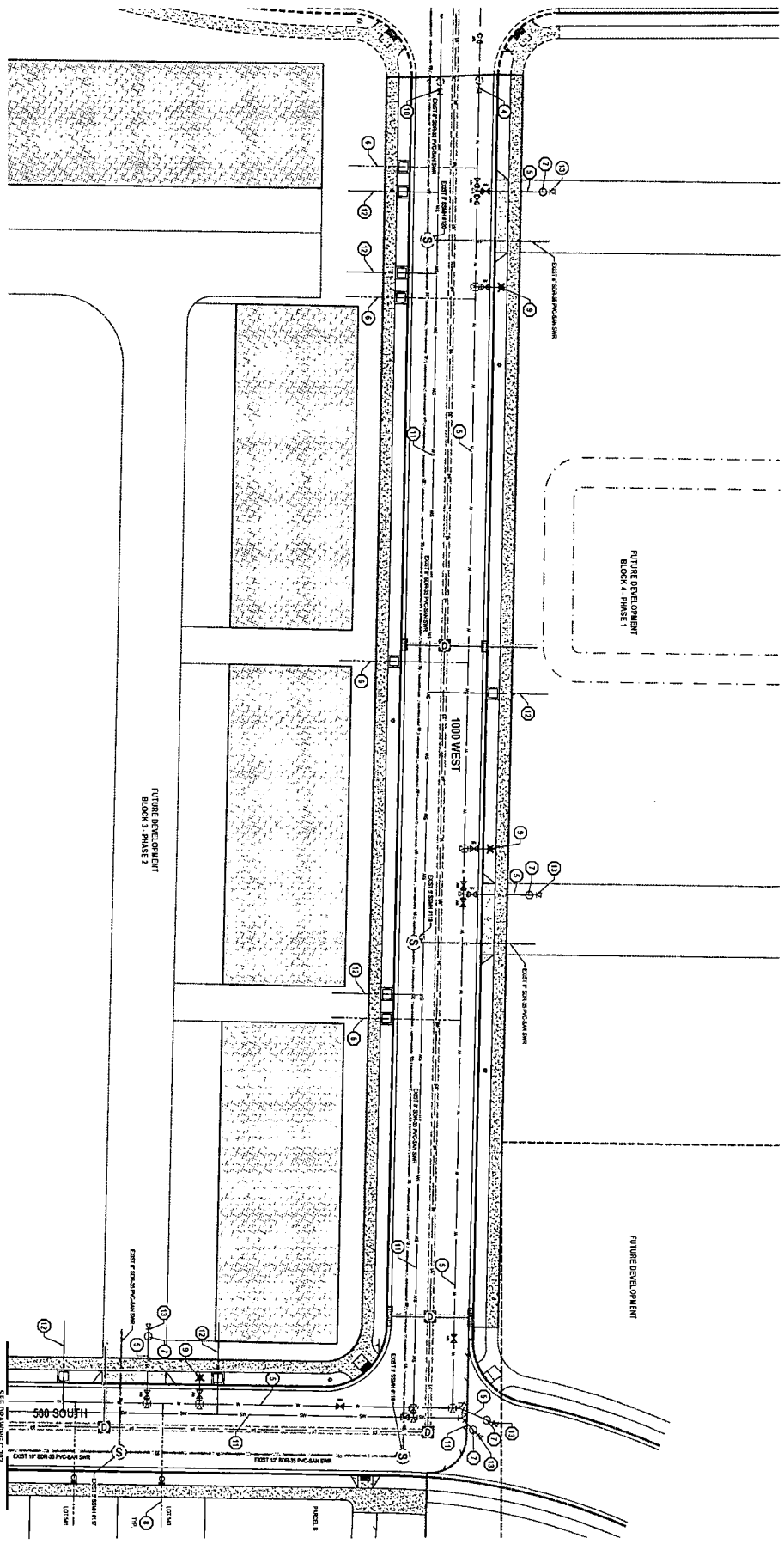
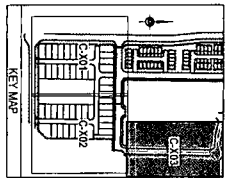

C-303

THE SPRINGS AT ROCKWELL RANCH
BLOCK 5 - PHASE 1
 1050 WEST 600 SOUTH
 AMERICAN FORK, UTAH 84003

ENSIGN
 THE STANDARD ENGINEERING
 5411 LAKE CITY
 SUITE 100
 SALT LAKE CITY, UT 84120
 PHONE 801.252.6529
 FAX 801.541.1100
TOOELE
 435.841.3500
 CEDAR CITY
 435.851.1433
 RICHFIELD
 435.897.2983

811
 CALL BEFORE YOU DIG
 811 UTAH SERVICE CENTER
 1-800-4-A-ROOT
 1-800-472-6842
 WWW.811.UTAH.GOV

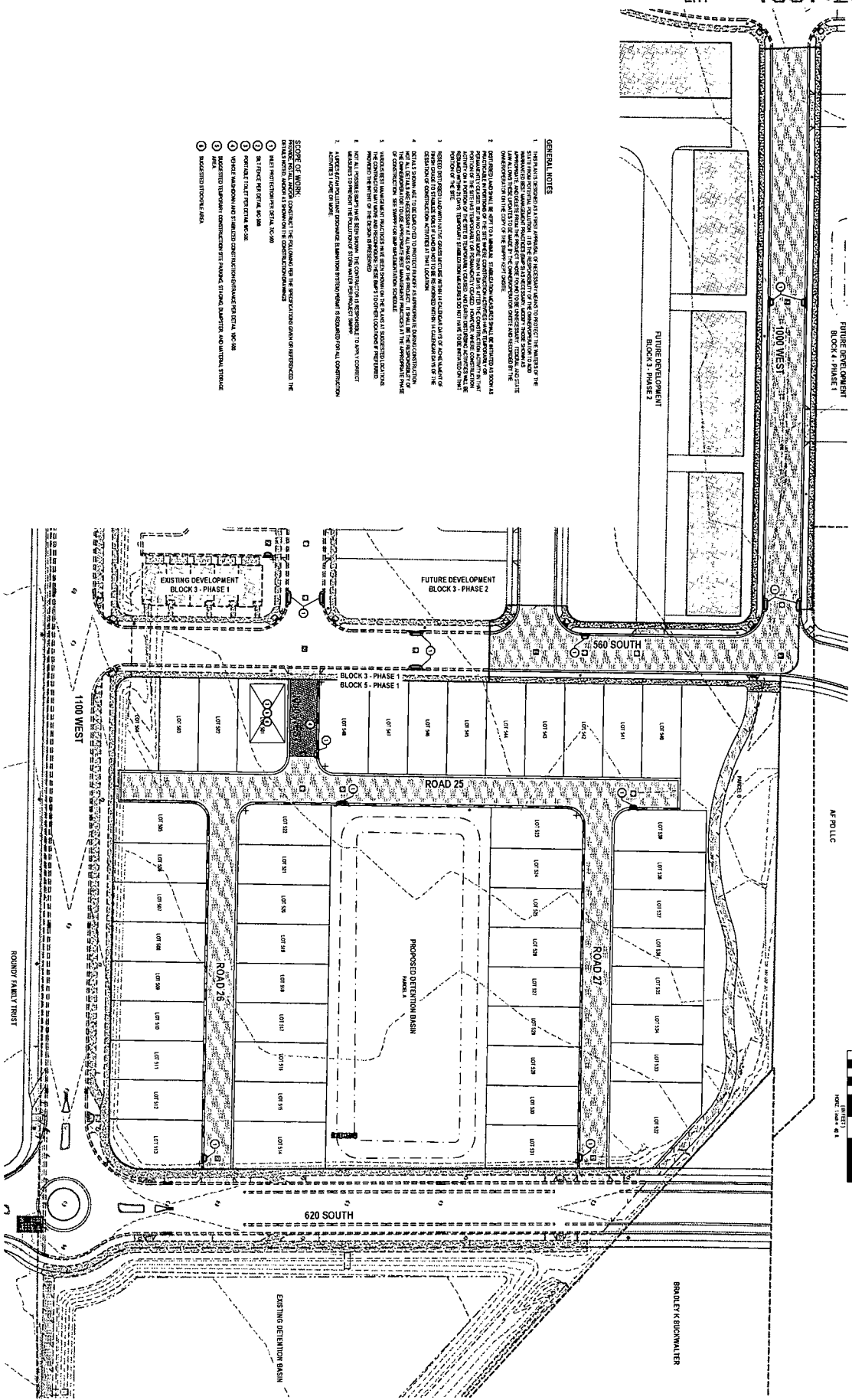

- GENERAL NOTES**
1. THE CONTRACTOR SHALL BE RESPONSIBLE FOR OBTAINING ALL NECESSARY PERMITS AND APPROVALS FROM THE APPROPRIATE AGENCIES AND AGENCIES.
 2. THE CONTRACTOR SHALL BE RESPONSIBLE FOR OBTAINING ALL NECESSARY PERMITS AND APPROVALS FROM THE APPROPRIATE AGENCIES AND AGENCIES.
 3. THE CONTRACTOR SHALL BE RESPONSIBLE FOR OBTAINING ALL NECESSARY PERMITS AND APPROVALS FROM THE APPROPRIATE AGENCIES AND AGENCIES.
 4. THE CONTRACTOR SHALL BE RESPONSIBLE FOR OBTAINING ALL NECESSARY PERMITS AND APPROVALS FROM THE APPROPRIATE AGENCIES AND AGENCIES.
 5. THE CONTRACTOR SHALL BE RESPONSIBLE FOR OBTAINING ALL NECESSARY PERMITS AND APPROVALS FROM THE APPROPRIATE AGENCIES AND AGENCIES.
 6. THE CONTRACTOR SHALL BE RESPONSIBLE FOR OBTAINING ALL NECESSARY PERMITS AND APPROVALS FROM THE APPROPRIATE AGENCIES AND AGENCIES.
 7. THE CONTRACTOR SHALL BE RESPONSIBLE FOR OBTAINING ALL NECESSARY PERMITS AND APPROVALS FROM THE APPROPRIATE AGENCIES AND AGENCIES.
 8. THE CONTRACTOR SHALL BE RESPONSIBLE FOR OBTAINING ALL NECESSARY PERMITS AND APPROVALS FROM THE APPROPRIATE AGENCIES AND AGENCIES.
 9. THE CONTRACTOR SHALL BE RESPONSIBLE FOR OBTAINING ALL NECESSARY PERMITS AND APPROVALS FROM THE APPROPRIATE AGENCIES AND AGENCIES.
 10. THE CONTRACTOR SHALL BE RESPONSIBLE FOR OBTAINING ALL NECESSARY PERMITS AND APPROVALS FROM THE APPROPRIATE AGENCIES AND AGENCIES.

ENSIGN
 THE STANDARD IN ENGINEERING
 5417 LAKE CITY
 43 W. 1000 S., SUITE 200
 RICHFIELD, UT 84601
 Phone: 801.252.6299
 Fax: 801.252.6299
 WWW.ENSIGNENGINEERING.COM

PROJECT INFORMATION
 PROJECT: THE SPRINGS AT ROCKWELL RANCH
 BLOCK 5 - PHASE 1
 PLAN: EROSION CONTROL PLAN
 DATE: 10/15/2021

SCALE
 1" = 40'

DATE
 10/15/2021

PROJECT NUMBER
 C-400

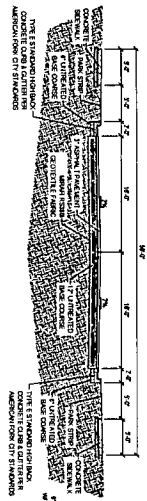

1 5' ROAD CROSS SECTION SCALE NONE

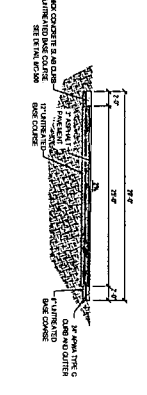

2 2' ROAD CROSS SECTION SCALE NONE

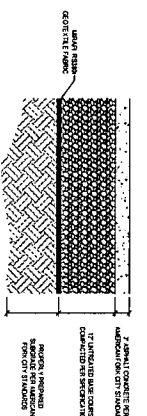

3 ASPHALT PAVEMENT SECTION SCALE NONE

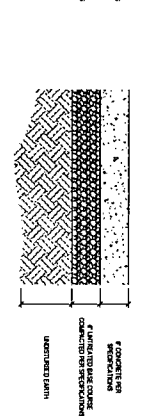

4 CONCRETE PAVEMENT SECTION SCALE NONE

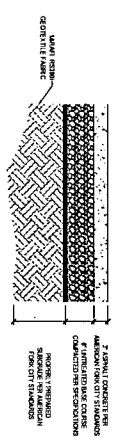

4A ASPHALT TRAIL PAVEMENT SECTION SCALE NONE

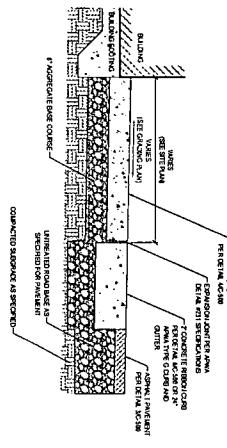

5 DRIVEWAY SCALE NONE

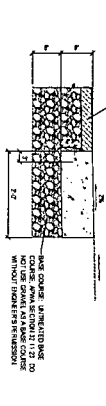

6 2" CONCRETE RIBBON CURB SCALE NONE

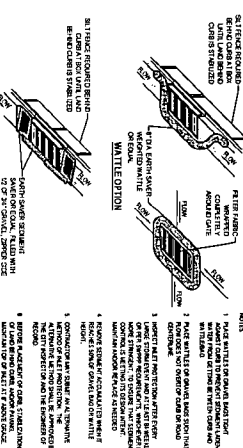

7 SAG INLET PROTECTION SCALE NONE

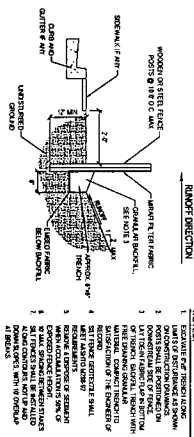

8 TEMPORARY SILT FENCE SCALE NONE

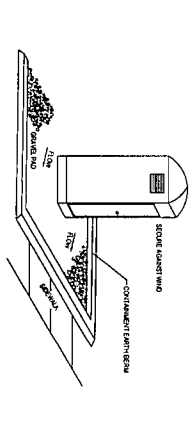

9 PORTABLE TOILET SCALE NONE

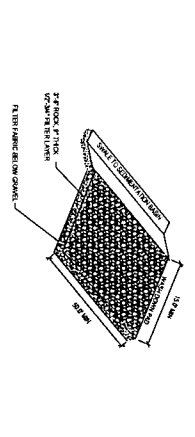

10 STABILIZED CONSTRUCTION ENTRANCE SCALE NONE

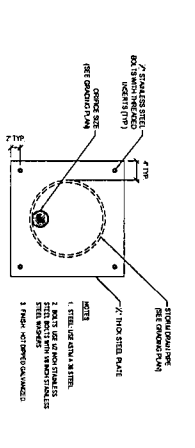

12 ORIFICE PLATE SCALE NONE

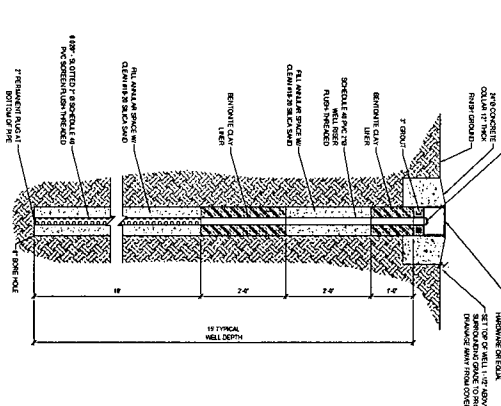

11 GROUNDWATER MONITORING WELL (W/ PEZOMETER) SCALE NONE

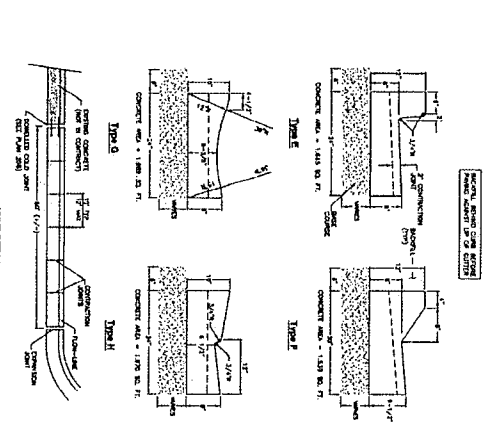

DETAILS SHEET SCALE NONE

ENIGN
THE STANDARD IN ENGINEERING

SALT LAKE CITY
43 W. 1000 S. Suite 300
Phone: 801.556.8099

LAYTON
7000 E. 15th St., 1100
Phone: 801.541.1100

TOOLONG
700 E. 8100 S. 3500
Phone: 801.556.1453

RICHFIELD
Phone: 435.969.2983

THE SPRINGS AT ROCKWELL RANCH
BLOCK 5 - PHASE 1
1050 WEST 600 SOUTH
AMERICAN FORK, UTAH 84003

WWW.ENIGNENR.COM

ENIGN ENGINEERING
1000 S. 1000 W.
SALT LAKE CITY, UT 84119
PHONE: 801.556.8099

DATE: 08/24/2021
TIME: 10:59:20 AM
PROJECT: 205.2
SHEET: 32 OF 32
C-500

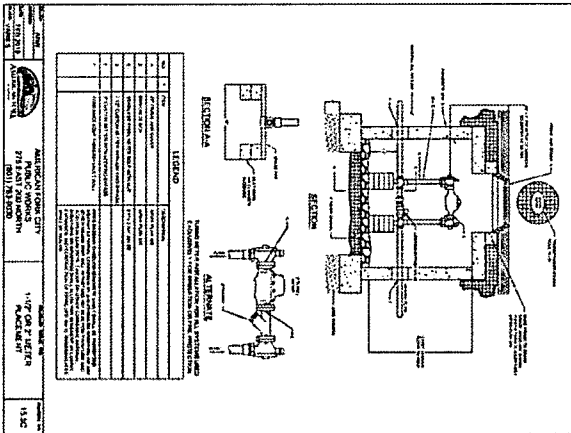
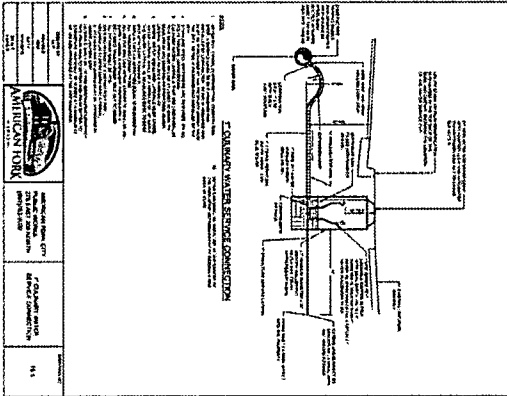
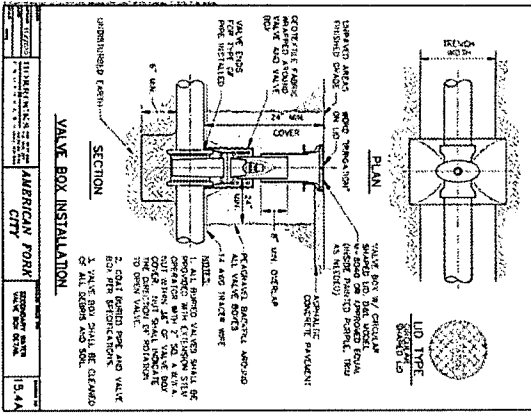
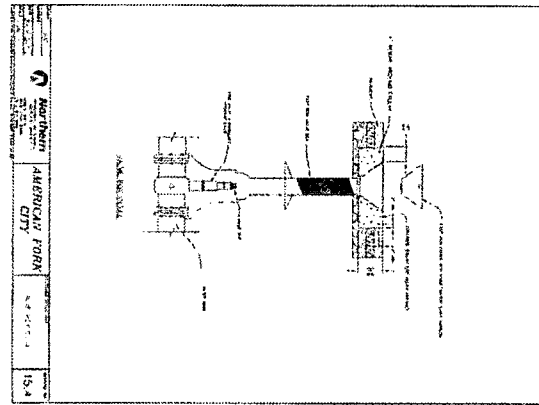
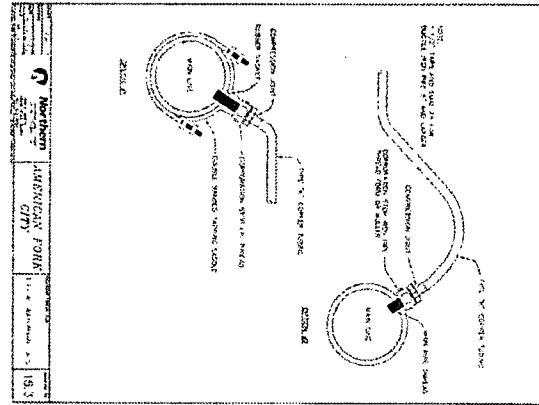
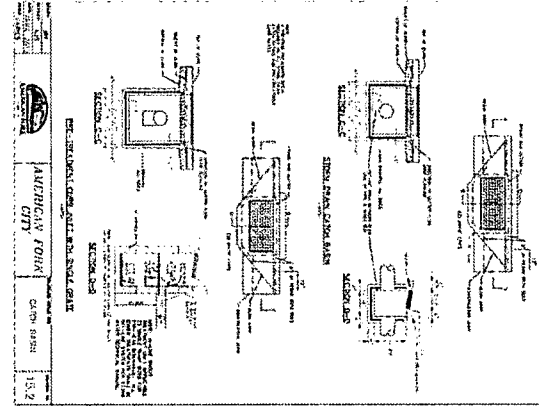
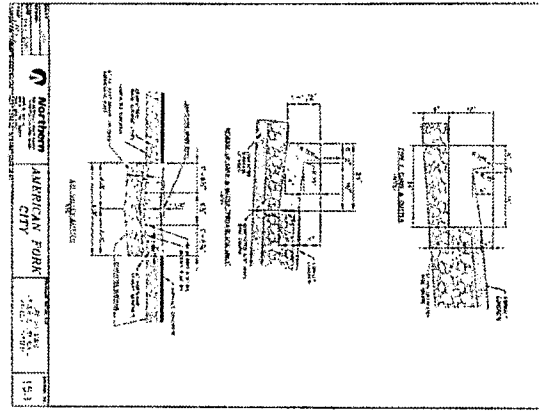

ENSGN
 THE STANDARD ENGINEERING

THE SPRINGS AT ROCKWELL RANCH
BLOCK 5 - PHASE 1
 1050 WEST 600 SOUTH
 AMERICAN FORK, UTAH 84003

547 LAKE CITY
 45 W. 1000 S., Suite 500
 Salt Lake City, UT 84119
 Phone: 801.466.8282

700 E. 1000 S., Suite 500
 Cedar Rapids, IA 52401
 Phone: 319.266.1453

1000 E. 1000 S., Suite 500
 Richfield, UT 84701
 Phone: 435.889.2883

WWW.ENSGN.COM

DETAILS SHEET

C-501

DATE: 07/20/21
 DRAWN BY: [Name]
 CHECKED BY: [Name]
 SCALE: AS SHOWN

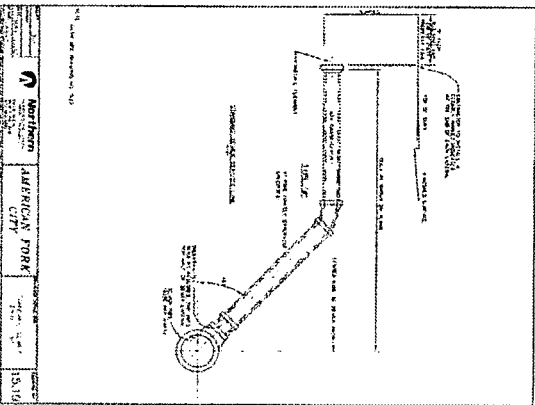
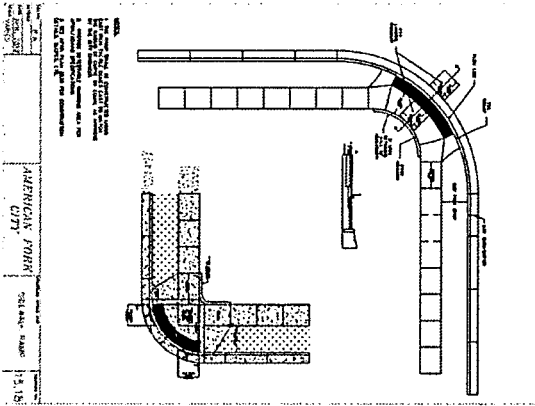
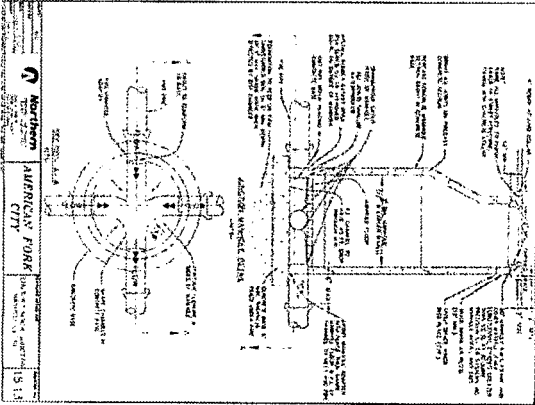
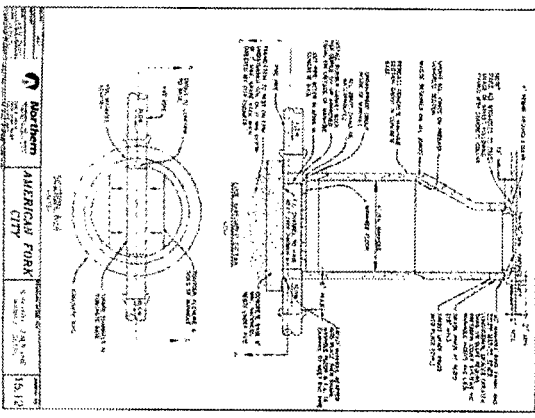
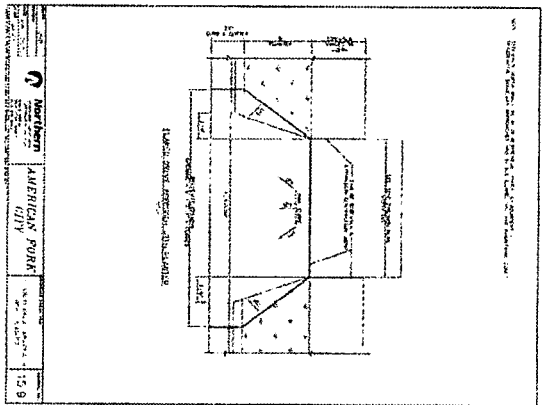
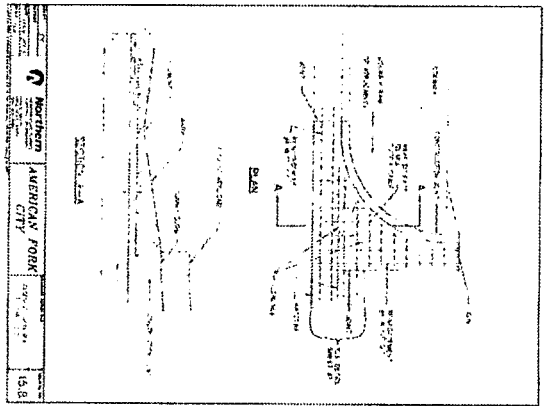
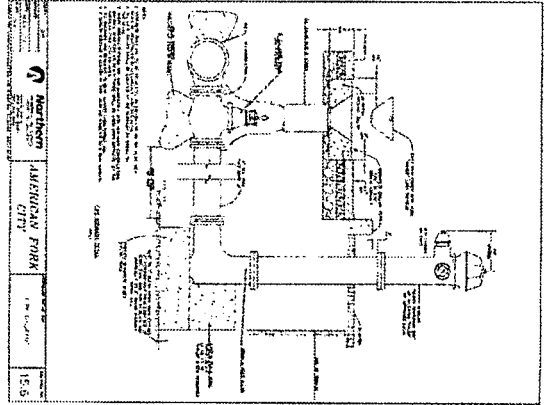
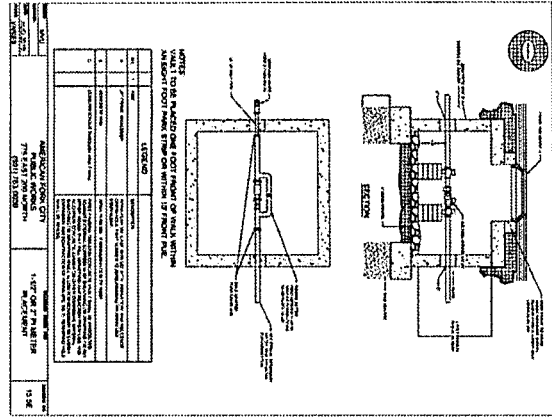

THE SPRINGS AT ROCKWELL RANCH
BLOCK 5 - PHASE 1
 1050 WEST 600 SOUTH
 AMERICAN FORK, UTAH 84003

EN SIGN
 THE SIMONSON ENGINEERING
 5411 LARK CITY
 45 W. 10000 S. Suite 400
 Sandy, UT 84070
 Phone 801.725.0229
 FAX 801.725.0229
 LATTON
 Phone 801.547.1100
 TOOLE
 Phone 435.943.3500
 CEDAR CITY
 Phone 435.943.3500
 RICHFIELD
 Phone 435.952.2903

WWW.ENSIGNENG.COM

DATE: 08/11/2021
 TIME: 10:00 AM
 USER: DAVID JENSEN
 PROJECT: 1050 WEST 600 SOUTH
 SHEET: 1050

C-502

DETAILS SHEET

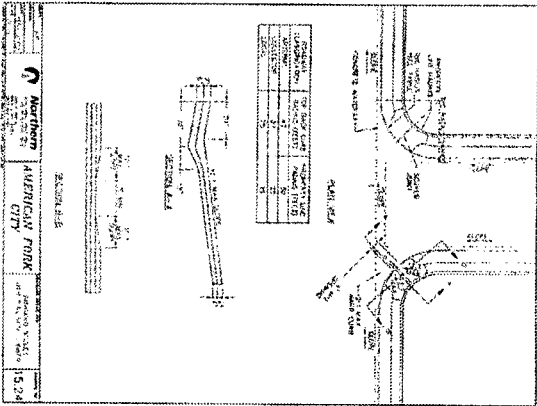
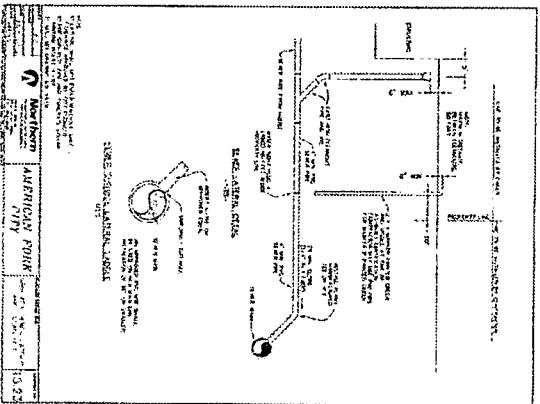
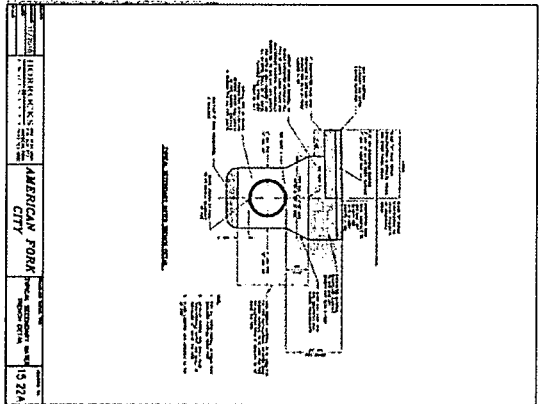
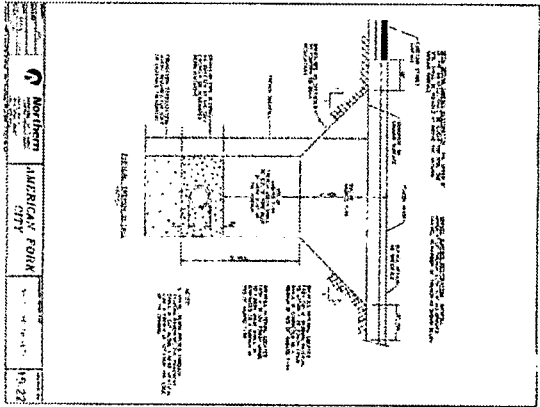
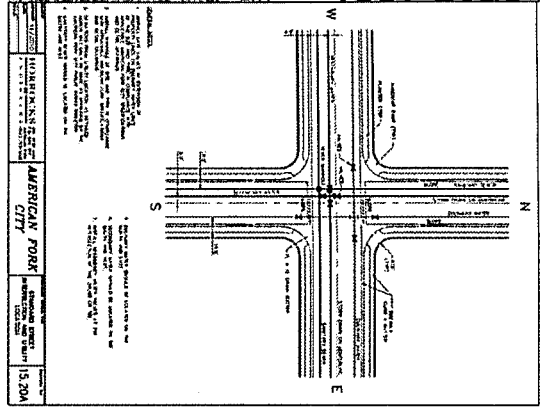

ENSIGN
THE STANDARD IN ENGINEERING

9417 LARK CIRCLE
SUITE 1000S, SALT LAKE CITY, UT 84140
PHONE 801.755.0799

LAYTON
PHONE 801.547.1100

TOOELE
PHONE 435.843.3500

CEDEAR CITY
PHONE 435.855.1453

RICHFIELD
PHONE 435.885.2983

THE SPRINGS AT ROCKWELL RANCH
BLOCK 5 - PHASE 1
1050 WEST 600 SOUTH
AMERICAN FORK, UTAH 84003

WWW.ENSIGNENGINEERING.COM

FOR MORE INFORMATION
CONTACT US AT 801.755.0799
OR VISIT OUR WEBSITE
WWW.ENSIGNENGINEERING.COM

DATE: 07/20/21
DRAWN BY: JACOB K. COOPER
CHECKED BY: JACOB K. COOPER
SCALE: AS SHOWN

PROJECT: THE SPRINGS AT ROCKWELL RANCH
BLOCK 5 - PHASE 1
SHEET: C-503

APPENDIX B – SOPs

Pavement Maintenance Operations

General:

These SOPs are not expected to cover all necessary procedure actions. Operators are allowed to adapt SOPs to unique site conditions in good judgment when it is necessary for safety, and the proper, and effective containment of pollutants. However, any changes of routine operations must be amended in these SOPs.

1. Purpose and Selection:

- a) Reduce stormwater pollution by sweeping and removing pollutants that will be carried to City stormwater systems during stormwater runoff or by non stormwater runoff.
- b) The sweeper is intended for removing material that collect on pavements by use and the natural degradation of pavements, ie. material that collect, drop from vehicles and the natural erosion and breaking up of pavements.

2. Regular Procedure:

- a) Remain aware of debris and sweep minor debris as needed by hand.
- b) Generally sweeping machinery should be used during autumn when leaf fall is heavy and early spring after winter thaw. Sometimes sweeping machinery will be necessary when accumulations are spread over a large area of the pavement.
- c) HOA roadways, driveways, and other hardscape areas will be swept.
- d) Manage outside activities that leave waste or drain pollutants to our pavements. This involves outside functions including but not limited to: Yard sales, yard storage, fund raisers, etc. Do not allow car wash fund raiser or other activities that allow detergents or other pollutants to be wash into storm drain systems.

4. Disposal Procedure:

- a) Service contractor dispose at licensed facilities
- b) Dispose of hand collected material in dumpster

5. Training:

- a) Annually and at hire

Landscape Maintenance Operations

General:

This SOP is not expected to cover all necessary procedure actions. Operators are allowed to adapt SOPs to unique site conditions in good judgment when it is necessary for safety, and the proper, and effective containment of pollutants. However, any changes of routine operations must be amended in this SOP.

Rule: Prevent any solids, liquids or any light weight material from being carried away from the construction or maintenance envelop by wind or water.

1. Application:

- a) This SOP should provide sufficient direction for many of the general landscaping operations, e.g., fertilizer and pesticide applications, mowing, weeding, tree trimming, digging, sprinkler repairs, varying landscape cover management, etc.

2. Maintenance Procedure:

- a) Grooming
 - Lawn Mowing – Immediately following operation sweep or blow clippings onto vegetated ground.
 - Fertilizer Operation – Prevent overspray. Sweep or blow fertilizer onto vegetated ground immediately following operation.
 - Pesticide Operations – Prevent overspray, use spot treatment, sweep or blow dry pesticide onto vegetated ground immediately following operation.
- b) Remove or contain all erodible or loose material prior forecast wind and precipitation events, before any non-stormwater will pass through and over the project site and at end of work period. Light weight debris and landscape materials can require immediately attention when wind expected.
- c) Landscape project materials and waste can usually be contained or controlled by operational best management practices.
 - Operational; including but not limited to:
 - Strategic staging of materials eliminating exposure, such as not staging on pavement
 - Avoiding multiple day staging of landscaping backfill and spoil on pavements
 - Haul off spoil as generated or daily
 - Scheduling work when weather forecast are clear.
- d) Cleanup:
 - Use dry cleanup methods, e.g. square nose shovel and broom and it is usually sufficient when no more material can be swept onto the square nosed shovel.
 - Power blowing tools

Long-Term Stormwater Management Plan
Rockwell Ranch Block 5 – Phase I

3. Waste Disposal:

- a) Dispose of waste according to General Waste Management SOP, unless superseded by specific SOPs for the operation.

4. Equipment:

- a) Tools sufficient for proper containment of pollutants and cleanup.
- b) Push broom and square blade shovel should be a minimum.

5. Training:

- a) Annually and at hire
- b) Landscape Service Contractors must have equal or better SOPs.

Waste Management Operations

General:

This SOP is not expected to cover all necessary procedure actions. Operators are allowed to adapt SOPs to unique site conditions in good judgment when it is necessary for safety, and the proper, and effective containment of pollutants. However, any changes of routine operations must be amended in this SOP.

1. Application:

- a) This SOP is intended for all Staff, intended for the proper disposal of common everyday waste.

2. Waste Collection.

- a) Regularly inspect and look for garbage, trash, and debris on-site including the detention pond and grounds. Collect and properly dispose of it.
- b) At winter time, inspection and collection will be done at fall during winterization and at spring time when the first cut occurs. The rest of the time it will be done weekly at same time as the cutting.

3. Waste Collection Devices (Exposed units):

- a) The site contains 2 types of waste management containers.
 - 6yd dumpster with lid
 - Receptacles with lids

4. Waste Disposal Restrictions for all waste Scheduled for the Intermountain Regional Landfill:

- a) Generally most waste generated at this property, and waste from spill and clean up operations can be disposed in our dumpsters under the conditions listed in this SOP. Unless other disposal requirements are specifically identified by the product SDS or otherwise specified in other SOPs.
- b) Know the facility disposal requirements and restrictions. It should not be assumed that all waste disposed in collection devices will be disposed at the Intermountain Regional Landfill.
- c) Review Intermountain Regional Landfill regulations for additional restrictions and understand what waste is prohibited in the Intermountain Regional Landfill. Ensure the SDS and Intermountain Regional Landfill regulations are not contradictory.

Generally the waste prohibited by the Intermountain Regional Landfill is:

- Liquid:
 - paint
 - pesticides/fertilizers

- oil (all types)
- antifreeze
- batteries
- liquid chemicals
- etc.

(Generally, all the above hazardous waste when involved in minor spill cleanup operations can be disposed in covered dumpsters and our waste bays, if the liquid is contained in absorbent material, e.g. sand, dirt, loose absorbent, pads, booms etc., and transformed or dried such that it will not drip. This is not intended for whole sale disposal of out dated or spent liquid hazardous waste. When disposal of out dated or spent liquid is needed or for questions of how to dispose of other waste, contact the Utah County Health Department for instructions and locations, (801-851-7331).

5. Waste Disposal Required for Intermountain Regional Landfill or other:

- a) Generally for waste not accepted by the Intermountain Regional Landfill.
- b) Follow SDS for disposal requirements. Review Intermountain Regional Landfill regulations for additional restrictions and understand what waste is prohibited in the Intermountain Regional Landfill. Ensure the SDS and Intermountain Regional Landfill regulations are not contradictory

General rules are:

- Get approval prior to delivery.
 - Transport waste in secure leak proof containers that are clearly labeled.
- c) Lookup and follow disposal procedures for disposal of waste at other EPA approved sites, the Intermountain Regional Landfill # is a good resource, (801) 930-0984

6. General Staff Maintenance Practices:

- a) Prevent dumpsters and receptacles from becoming a pollution source by:
 1. Closing lids
 2. Reposition tipped receptacles upright.
 3. Report full or leaking and unsecured dumpsters and receptacles to the company provider or repair it in house. Determine source liquids and prevent it.
 4. Report any eminent pollutant hazard related to dumpsters and receptacles to the owner.

6. Training:

- a) Annually and at hire

Storm Drain Maintenance Operations

General:

These SOPs are not expected to cover all necessary procedure actions. Operators are allowed to adapt SOPs to unique site conditions in good judgment when it is necessary for safety, and the proper, and effective containment of pollutants. However, any changes of routine operations must be amended in these SOPs.

1. Procedure:

- a) Inspect for need:
 1. Schedule cleaning for boxes and pipe that contain 2” or more of sediment and debris.
 2. Remove debris by vacuum Intermountain Regional Landfill operated machinery.
 3. When accumulations are mostly floating debris this material can be removed with a net.
 4. Inspect standing water for mosquito larvae and contact Utah County Health Department – Mosquito Abatement when necessary.
 5. Inspect at time of winterization.

2. Disposal Procedure:

- a) Dispose of waste collected by machinery at regulated facilities.
- b) Floating materials and floating absorbent materials may be disposed in dumpster when dried out. Dry dirt and slurry may also be disposed in the dumpster.
- c) Disposal of hazardous waste
 1. Dispose of hazardous waste at regulated disposal facilities, see Waste Management and Spill Control SOP
- d) Disposal of waste collected from storm drain device at regulated facilities.
 1. UniStorm Stormwater Treatment System is installed with this development and the recommended maintenance practice for the UniStorm System is to plan on quarterly inspections and an annual pump-out. See *Appendix C* for manufacturer’s recommendations.

3. Training:

- a) Annually and at hire

Pavement Washing Operations

General:

These SOPs are not expected to cover all necessary procedure actions. Operators are allowed to adapt SOPs to unique site conditions in good judgment when it is necessary for safety, and the proper, and effective containment of pollutants. However, any changes of routine operations must be amended in these SOPs.

1. Procedure:

- a) Prevent waste fluids and any detergents if used from entering storm drain system. The following methods are acceptable for this operation.
 - Dam the inlet using a boom material that seals itself to the pavement and pick up the wastewater with shop-vacuum or absorbent materials.
 - Collect wastewater with shop-vacuum simultaneous with the washing operation.
 - Collect wastewater with vacuum truck or trailer simultaneous with the washing operation.
- b) This procedure must not used to clean the initial spills. First apply the Spill Containment and cleanup SOP.

2. Disposal Procedure:

- a) Small volumes can usually be drained to the local sanitary sewer. Contact the Timpanogos Special Service District.
- b) Large volumes must be disposed at regulated facilities.

2. Pavement Cleaning Frequency:

- a) There is no regular pavement washing regimen. Pavement washing is determined by conditions that warrant it, including but not limited to: prevention of slick or other hazardous conditions or restore acceptable appearance of pavements.

3. Training:

- a) Annually and at hire

Snow and Ice Removal Management

General:

This SOP is not expected to cover all necessary procedure actions. Operators are allowed to adapt SOPs to unique site conditions in good judgment when it is necessary for safety, and the proper, and effective containment of pollutants. However, any changes of routine operations must be amended in this SOP.

1. Application:

- a) Parking and sidewalk winter management operations.

2. De-Icing Procedure:

- a) Do not store or allow salt or equivalent to be stored on outside paved surfaces. Storage of salt or other de-icing agents will be the responsibility of the snow and ice service contractor.
- b) Minimize salt use by varying salt amounts relative to hazard potential.
- c) Sweep excessive piles left by the spreader.
- d) Store snow in designated snow storage easements per TOD code. See *Appendix A – Site drawings and details* for location of snow storage easements.
- e) Watch forecast and adjust salt amounts when warm ups are expected the same day.

3. Training:

- a) Annually and at hire.
- b) Require snow and ice service contractors to follow the stronger this SOP and their company SOPs.

General Construction Maintenance

General:

This SOP is not expected to cover all necessary procedure actions. Operators are allowed to adapt SOPs to unique site conditions in good judgment when it is necessary for safety, and the proper, and effective containment of pollutants. However, any changes of routine operations must be amended in this SOP.

Rule: Prevent any solids, *liquids or any light weight material from being carried away from the construction or maintenance envelop by wind or water.

***liquids - including culinary water and irrigation water that are polluted with material that will damage the environment.**

1. Application:

- a) This SOP should provide sufficient direction for many of the general operations, e.g., building maintenance, curb/sidewalk/flatwork, overlay/patching, landscape renovations, misc. maintenance/repairs, etc.

2. Construction Procedure:

- a) Remove or contain all erodible or loose material prior forecast wind and precipitation events or before non-stormwater will pass through the project site. For light weight debris maintenance can require immediately attention for wind events and many times daily maintenance or as needed for precipitation or non-stormwater events.
- b) Project materials and waste can be contained or controlled by operational or structural best management practices.
 - Operational; including but not limited to:
 - Strategic staging of materials eliminating exposure, such as not staging on pavement
 - Avoiding multiple day staging of backfill and spoil
 - Haul off spoil as generated or daily
 - Schedule work during clear forecast
 - Structural; including but not limited to:
 - Inlet protection, e.g. wattles, filter fabric, drop inlet bags, boards, planks
 - Gutter dams, e.g. wattles, sandbags, dirt dams
 - Boundary containment, e.g. wattles, silt fence
 - Dust control, e.g. water hose,
 - Waste control, e.g. construction solid or liquid waste containment, dumpster, receptacles

- c) Inspect often to insure the structural best management practices are in good operating condition and at least prior to the workday end. Promptly repair damaged best management practices achieving effective containment.
- d) Cleanup:
 - Use dry cleanup methods, e.g. square nose shove and broom.
 - Wet methods are allowed if wastewater is prevented from entering the stormwater system, e.g. wet/dry vacuum, disposal to our landscaped areas.
- e) Cleanup Standard:
 - When a broom and a square nosed shovel cannot pick any appreciable amount of material.

3. Waste Disposal:

- a) Dispose of waste according to General Waste Management SOP, unless superseded by specific SOPs for the operation.
- b) Never discharge waste material to storm drains

4. Equipment:

- a) Tools sufficient for proper containment of pollutants and cleanup.
- b) Push broom and square blade shovel should be a minimum.

5. Training:

- b) Annually and at hire.

Spill Control

General:

This SOP is not expected to cover all necessary procedure actions. Operators are allowed to adapt SOPs to unique site conditions in good judgment when it is necessary for safety, and the proper, and effective containment of pollutants. However, any changes of routine operations must be amended in this SOP.

1. Rational:

- a) All properties are susceptible to spills whether it is a result of operations or by customers. Insufficient response, inadequate containment materials and improper spill cleanup methods will result in pollutants in our waterways. Once the pollutants reach our storm drain system, or even the detention pond, they are difficult and expensive to remove.

2. Containment Procedure:

- a) Priority is to dam and contain flowing spills.
- b) Use spill kits booms if available or use any material available; including but not limited to, nearby sand, dirt, landscaping materials, etc.
- c) Hazardous or unknown waste material spills
 1. Critical Emergency constitutes large quantities of flowing uncontained liquid that will affect areas with people or reach storm drain systems. Generally burst or tipped tanks. Call HAZMAT, Department of Water Quality, Utah County Health Department, and American Fork City.
 2. Minor Emergency constitutes a spill that has reached a storm drain but is no longer flowing. Call Utah County Health Department, American Fork City
 3. Spills that are contained on the surface and do not meet the criteria for Critical and minor emergencies may be managed by the responsible implementation of this SOP.
 4. Contact Numbers:
HAZMAT - 911
Department of Water Quality – 801-231-1769, 801-536-4123
Utah County Health Department – (801) 851-7000
American Fork City – (801) 763-3000

3. Cleanup Procedure:

- a) NEVER WASH SPILLS TO THE STORM DRAIN SYSTEMS.
- b) Clean per SDS requirements but generally most spills can be cleaned up according to the following:
 - Absorb liquid spills with spill kit absorbent material, sand or dirt until liquid is sufficiently converted to solid material.

- Remove immediately using dry cleanup methods, e.g. broom and shovel, or vacuum operations.
- Cleanup with water and detergents may also be necessary depending on the spilled material. However, the waste from this operation must be vacuumed or effectively picked up by dry methods. See Pavement Washing SOP.
- Repeat process when residue material remains.

4. DISPOSAL:

- a) Follow SDS requirements but usually most spills can be disposed per the following b. & c.
- b) Generally most spills absorbed into solid forms can be disposed to the dumpster and receptacles. Follow Waste Management SOP.
- c) Generally Liquid waste from surface cleansing processes may be disposed to the sanitary sewer system after the following conditions have been met:
 - Dry cleanup methods have been used to remove the bulk of the spill and disposed per the Waste Management SOP.
 - The liquid waste amounts are small and diluted with water. This is intended for spill cleanup waste only and never for the disposal of unused or spent liquids.

5. Documentation:

- a) Document all spills in Appendix C.

6. SDS sheets:

- a) SDS Manual is filed in break room.

7. Materials:

- a) Generally sand or dirt will work for most clean up operations and for containment. However, it is the responsibility of the owner to select the absorbent materials and cleanup methods that are required by the SDS Manuals for chemicals used by the company.

8. Training:

- a) Annually and at hire.

APPENDIX C – UNISTORM SYSTEM OPERATION AND MAINTENANCE MANUAL



UNISTORM OPERATION AND MAINTENANCE MANUAL

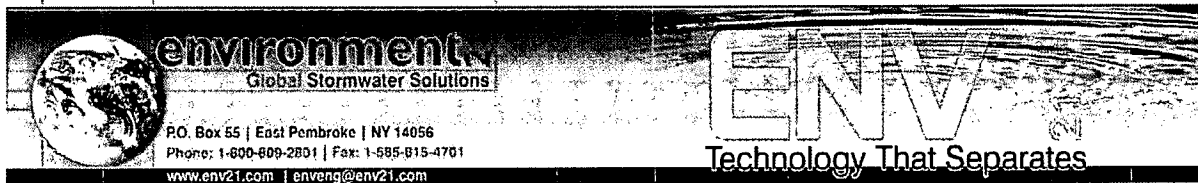

UNISTORM SYSTEM MAINTENANCE

1.0 UNISTORM DESCRIPTION

- 1.1 The UniStorm is a precast concrete structure. It is available in different configurations (e.g., with an at grade inlet grate, flow control, etc.) and with different attachments (e.g., flow control vanes, flow diffusers, etc.).
- 1.2 The UniStorm System consists of stages of treatment separated by a precast concrete baffle walls. The baffle walls are designed to meet site-specific flow requirements and provide four functions:
 - (a) Removes floatables and sediment in the inlet stage
 - (b) Provides a low head loss flow path between the first and second stages
 - (c) Provides for additional sediment removal in the second stage.
 - (d) Provides flow control either with vanes mounted on the upstream side of the baffle wall or through diversion baffles.
- 1.3 The UniStorm Systems are manufactured from standard precast concrete components. These components are designed to reduce the weight that needs to be handled during shipment and installation.
- 1.4 Normal water depth in the UniStorm System structure sump will be 3-6 ft dependent on the project requirements. This shallow sump reduces excavation costs and the depth to be accessed from a standard vacuum truck (13' lift).
- 1.5 Cast iron access frames vented covers, or hatches are provided in the UniStorm System roof to make the sediment pile readily accessible for measurement and cleaning in each stage of the structure.
- 1.6 Standing water tends to be an attraction for mosquitoes to use as a breeding ground, therefore Environment 21, LLC recommends using solid covers with gaskets or bio-safe mosquito tablets or a combination of both.

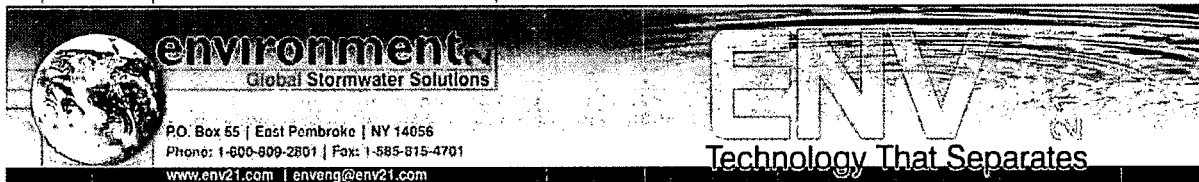

2.0 POLLUTANT STORAGE CAPACITY AND CLEANOUT FREQUENCY

- 2.1 The recommended maintenance practice for the UniStorm System is to plan on quarterly inspections and an annual pump-out based on the following general design guidelines:
- 2.1.1 Sediment Sump -- the rate at which sediment is accumulated will depend on land use and other pavement activities (e.g., heavy winter sanding will create extra sediment, while regular sweeping will reduce accumulation). The UniStorm System structure sump is designed to store an average sediment pile depth of up to 1.0 ft. Environment 21 recommends that the sediment should be removed when the first-stage sediment pile depth is 6"-12"
 - 2.1.2 Floatables Chambers -- oil sheen and floating debris will be retained in the inlet stage of the UniStorm System. Annual accumulation of floatables is estimated at less than 0.50 inches but can vary depending on land use.
 - 2.1.3 During the first one to two years of operation, Environment 21 recommends visual inspections in January, April, July, and October. This inspection schedule may be modified in subsequent years according to experience or to meet specific stormwater permit requirements.
 - 2.1.4 Refer to the Environment 21 system specific design package for the estimated maintenance interval or call 1-800-809-2801.

3.0 SAFETY

- 3.1 Safety is a priority and the following are recommended guidelines while performing maintenance on UniStorm Systems. These guidelines are not all-inclusive and by no means are they meant to usurp any safety program already in place for the individuals performing the maintenance on the UniStorm System.
- 3.1.1 The UniStorm System is a confined space structure but entry into it is not required and is not recommended by

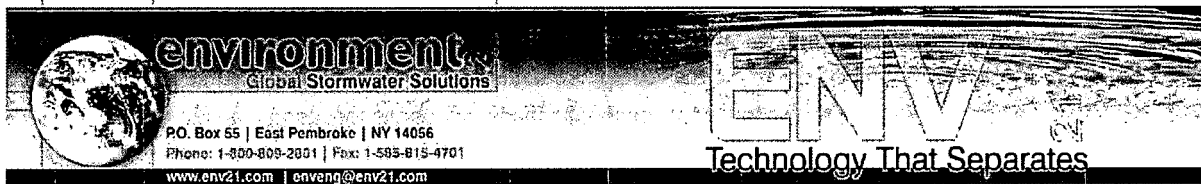

Environment 21, LLC. The design of the UniStorm System is such that all of the maintenance may be completed without entry. In the remote chance that entry into the UniStorm System structure is required only trained, qualified workers with the proper Personal Protective Equipment (PPE) should perform the entry.

3.1.2 The UniStorm System has cast iron access frames with covers which provide access to all stages of the UniStorm system. The openings are normally at ground level so the work area should be staged properly with safeguards to prevent anyone or anything from inadvertently falling through an opening in the UniStorm System structure. The access openings provided are usually sized at 24" or 30", dependent on the diameter of the structure, and conform to ASTM C478 specifications.

3.1.3 After maintenance has been completed on the UniStorm System, the area should be cleared of slip and trip hazards and the cast iron covers set securely in place.

4.0 FLOATABLES OBSERVATION AND MEASUREMENT

- 4.1 Maintain an inventory all tools and equipment used for completion of this procedure.
- 4.2 Obtain a flood light and a measuring rod (increments in inches marked on the rod). The measuring rod must be of a length that will reach the floor of the UniStorm System structure and still extend a minimum of 2' above the cast iron access frame. The rod should not bend.
- 4.3 Set up the work area using proper safety procedures, equipment (e.g., barricades) and PPE as required.
- 4.4 Carefully remove the cast iron covers using proper lifting and rigging equipment; set the covers off to the side in a safe area and safe configuration (e.g., not suspended).
- 4.5 Illuminate the water surface in the inlet stage of the UniStorm System with the flood light.

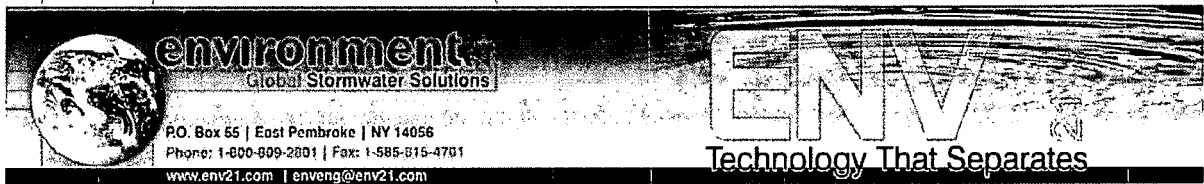

- 4.6 Gently stir the floatables to estimate the depth. Obtain a sample of the floatables, water, or sediment, if required, for waste disposal. The depth of the oil sheen and floating debris will typically be less than one inch and can be skimmed from the surface prior to the pump-out of the sediment. Organic debris that has become waterlogged and settled to the floor is expected to be present in relatively small quantities that will be removed during the pump out of the mineral sediment.
- 4.7 Inspect all surfaces, which can be seen, of the UniStorm System structure for wear (e.g., cracking, spalling, etc.). Report signs of degradation to the proper authorities (i.e., owner, municipality, etc.).
- 4.8 Repeat steps 4.6 and 4.7 for any other stages of the UniStorm System.

5.0 SEDIMENT PILE DEPTH MEASUREMENT

- 5.1 Complete section 4.0 of this procedure prior this section.
- 5.2 Lower the measuring rod (from step 4.2) into the inlet stage of the UniStorm System structure until a slight resistance to movement occurs; the rod is now at the top of the sediment pile. Obtain a sight measurement by sighting the rod measuring increments to a point on the cover frame.
- 5.3 Twist the measuring rod into the sediment pile until the measuring rod is on the floor (verify the expected level using project submittal drawings). Obtain a sight measurement by sighting the rod increments to the same point on the access frame as was used in step 5.2. Subtract the smaller number from the larger number as obtained in this step and step 5.2. For example, if the measurement in step 5.2 is 8' 0" and the measurement in step 5.3 is 8' 3" subtract the 8' 0" from the 8' 3". The resultant 3" is the sediment depth of the UniStorm Manhole.
- 5.4 Repeat steps 5.2 and 5.3 for any other stages of the UniStorm System.
- 5.5 If pump-out of the UniStorm System is required and will occur immediately go to Section 6.0 of this procedure; if not go to Section 7.0 of this procedure.

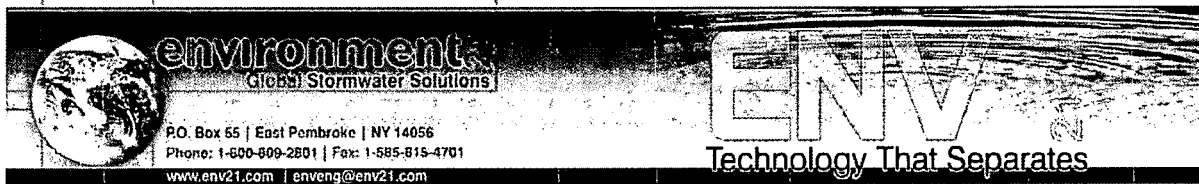

6.0 PUMP-OUT OF THE UNISTORM SYSTEM

- 6.1 Contact the following for approval and notification of the intent to pump out the UniStorm System:
 - 6.1.1 Owner
 - 6.1.1.1 Obtain permission from the Owner to pump out the contents of the UniStorm System.
 - 6.1.2 Waste Disposal Facility
 - 6.1.2.1 Facilities used by the local Highway Department may be acceptable, while, for industrial sites, the pumper truck contents should be delivered to a disposal site approved by the owner of the industrial site and disposed of in accordance with local requirements for disposal of pollutants.
 - 6.1.2.2 Obtain permission to deliver the waste to the facility.
 - 6.1.3 Government Agencies
 - 6.1.3.1 Obtain permission, as required, from local, State and Federal Agencies.
- 6.2 Obtain a standard truck-mounted sewer and catch basin cleaner with positive displacement rotary lobe vacuum pumps or other acceptable pump-out equipment.
- 6.3 If the area was secured after the inspection and Section 7.0 was performed complete steps 4.2 and 4.3 of this procedure.
- 6.4 Using the truck-mounted sewer and catch basin cleaner, suction the floatables and hydrocarbons from the inlet stage. Segregate this waste from the sediment and water as required by the local regulations and the waste facility.
- 6.5 Using the truck-mounted sewer and catch basin cleaner, suction the standing water and sediment from the inlet stage. Segregate this waste from the hydrocarbons and floatables as required by the local regulations and the waste facility.

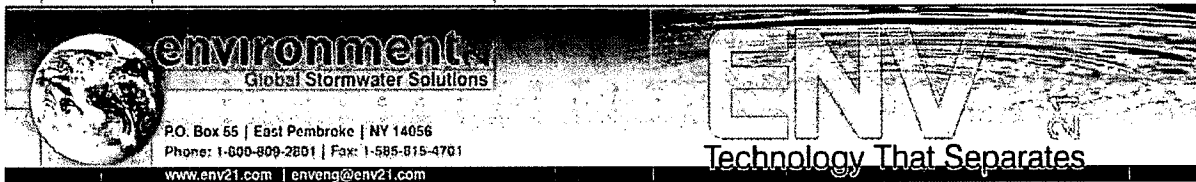

- 6.6 Using the water supply from the vacuum truck wash down the interior surface of the UniStorm system and suction any waste and water from the bottom of the structure.
- 6.7 Repeat steps 6.4 through 6.6 for any other stages of the UniStorm System.
- 6.8 Using a flood light inspect all surfaces, which can be seen, of the UniStorm System structure for wear (e.g., cracking, spalling, etc.). Report signs of degradation to the proper authorities (i.e., owner, municipality, etc.).
- 6.9 Refill the UniStorm System, with clean water, to the inlet/outlet pipe invert elevation.
- 6.10 Properly dispose of the waste removed from UniStorm System as pre-arranged

7.0 SECURING THE AREA

- 7.1 Verify that no personnel, tools or equipment are in the UniStorm System structure.
- 7.2 Inspect the cast iron access frames and covers for damage (e.g., cracks, excessive wear, etc.).
- 7.3 Clear the cast iron access frames of any extraneous material and carefully replace the cast iron covers using proper lifting and rigging equipment. Verify that the covers are properly seated.
- 7.4 Remove the site set-up (tools, equipment, etc.) and verify the work area has been returned to its pre-work condition.
- 7.5 Complete an inventory of all tools and equipment used for this work, accounting for lost, damaged, or stolen tools or equipment.

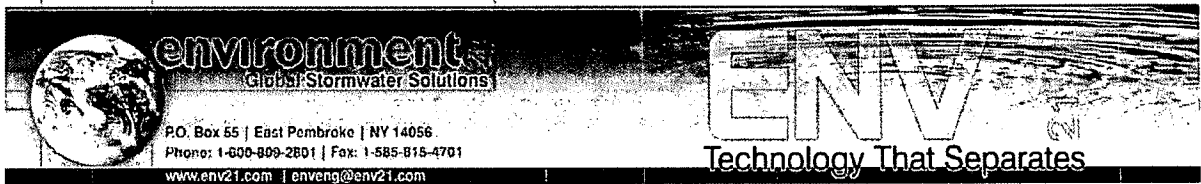

8.0 RECORD KEEPING

- 8.1 Maintenance is a very important aspect in keeping the UniStorm System performance up to par. The attached "UNISTORM SYSTEM MAINTENANCE DATA SHEET" is provided and should be used to document the maintenance performed on the UniStorm System.
- 8.2 Provide a copy of the "UNISTORM SYSTEM MAINTENANCE DATA SHEET" to the owner, required government agencies, and Environment 21, LLC (P.O. Box 55, East Pembroke, NY 14056-1055).

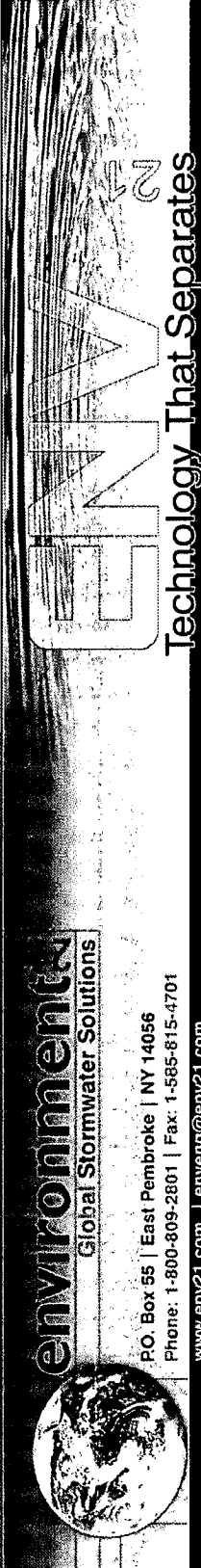

Environmenta
Global Stormwater Solutions

P.O. Box 55 | East Pembroke | NY 14056
Phone: 1-800-809-2801 | Fax: 1-585-815-4701
www.env21.com | enveng@env21.com

ENV21
Technology That Separates

UNISTORM SYSTEM MAINTENANCE DATA SHEET

STRUCTURE NO.: _____ LOCATION: _____
 OWNER: _____ UNISTORM MODEL _____

DATE INSTALLED: _____ MUNICIPALITY: _____

DATE	SEDIMENT PILE DEPTH	OIL SHEEN YES/NO	FLOATABLE DEPTH	PUMPOUT REQ. YES/NO	SAMPLED YES/NO	SAMPLE RESULTS

PUMPOUT DATA (IF APPLICABLE)

DATE	SEDIMENT VOLUME REMOVED	FLOATABLES VOLUME REMOVED	SEDIMENT/FLOATABLE DISPOSAL INFORMATION:	
			WHERE DISPOSED	HOW DISPOSED

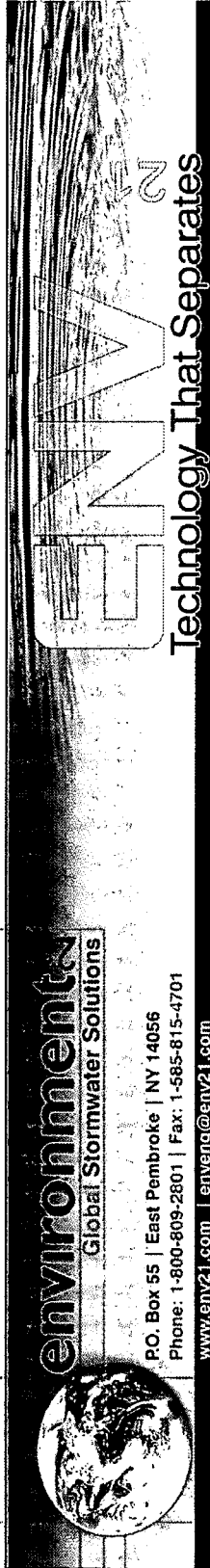

Environment21
Global Stormwater Solutions

P.O. Box 55 | East Pembroke | NY 14056
Phone: 1-800-809-2801 | Fax: 1-585-815-4701
www.env21.com | enveng@env21.com

ENV21
Technology That Separates

PRIOR TO START OF WORK

- OWNER NOTIFIED AS REQUIRED.
- GOVERNMENT AGENCIES NOTIFIED AS REQUIRED.
- DISPOSAL SITE CONTACTED (IF PUMPOUT IS REQUIRED.)
- ALL REQUIRED PPE, TOOLS, AND EQUIPMENT ARE AVAILABLE AND IN GOOD WORKING ORDER.

AFTER WORK COMPLETION

- ANY SIGNS OF WEAR NOTED AND REPORTED IF NECESSARY
- UNIFORM SYSTEM HAS BEEN FILLED WITH CLEAN WATER
- ALL CAST IRON COVERS HAVE BEEN PROPERLY REPLACED.
- NO HAZARDOUS CONDITIONS EXIST AS A RESULT OF THE MAINTENANCE WORK.
- ALL PPE, TOOLS, AND EQUIPMENT HAVE BEEN INVENTORIED AND REMOVED FROM THE SITE.
- THE WORK AREA HAS BEEN RETURNED TO A SAFE PRE-WORK CONDITION.
- ALL NOTIFICATIONS HAVE BEEN MADE, AS REQUIRED, THAT THE WORK IS COMPLETED.

DATE: _____ SIGNATURE: _____

Exhibit C

Approved as to form:
Attorney for American Fork City

APPENDIX D – PLAN RECORDKEEPING DOCUMENTS

MAINTENANCE/INSPECTION SCHEDULE

Frequency	Site Infrastructure
	Replace text with the infrastructure / system that must be maintained; repeat

Inspection Frequency Key: A=annual, Q=Quarterly, M=monthly, W=weekly, S=following appreciable storm event, U=Unique infrastructure specific (specify)

RECORD INSPECTIONS IN THE MAINTENANCE LOG

Inspection Means: Either; Traditional walk through, Awareness/Observation, and during regular maintenance operations while noting efficiencies/inefficiencies/concerns found, etc.

Long-Term Stormwater Management Plan
Rockwell Ranch Block 5 – Phase I

MAINTENANCE LOG

Date	Maintenance Performed/Spill Events Perform Maintenance per SOPs	Observation Notes, including but not limited to: Inspection results, Observations, System Performance (effectiveness/inefficiencies), SOP Usefulness, Concerns, Necessary Changes	Initials

Annual Summary of LITSWMP effectiveness, inefficiencies, problems, necessary changes etc.
Empty space for annual summary

*You may create your own form that provides this same information or request a word copy of this document.

Long-Term Stormwater Management Plan
Rockwell Ranch Block 5 – Phase 1

Annual SOP Training Log per Section 2

SOP	Trainer	Employee Name/ Maintenance Contractor Co.	Date

*You may create your own form that provides this same information or request a word copy of this document.

Exhibit D

Facility Operation and Maintenance Inspection Report for Storm Drain Facilities

Inspector Name:		Subdivision Name:				
Inspection Date:		Address:				
Frequency of inspection		<input type="checkbox"/> Weekly	<input type="checkbox"/> Monthly		<input type="checkbox"/> Quarterly	<input type="checkbox"/> Annual
Item Inspected	Checked		Maintenance		Observations and Remarks	
	Yes	No	Req'd	Not Req'd		
Pond Facilities						
1	Landscaping maintenance					
2	Remove sedimentation					
3	Remove debris					
4	Repair side slopes					
5	Repair rip-rap protection					
6	Repair control structure					
7	Cleaning of outfall					
8	Removal of floatable debris					
9	Maintenance of inlets					
10	Maintenance of outlets					
Storm drain system						
1	Remove sediment from catch basins					
2	Cleaning storm drain pipes					
3	Maintenance of drainage swales					
4	Remove sediment from manholes					
5	Remove sediment from sumps					
6	Repair oil/ water separator					
7	Repair sand filters					
Parking lot and roads maintenance						
1	Sweeping of parking lot					
2	Sweeping of streets					
3	Cleaning of garbage enclosure					
4	Cleaning of non-hazardous spills					
5	Managing fertilizer use					
6	Managing pesticide use					
7	Removal of grass after lawn mowing					

I certify under penalty of law that this document and all attachments were prepared under my direction or supervision in accordance with a system designed to ensure that qualified personnel properly gather and evaluate the information submitted. Based on my inquiry of the person or persons who manage the system, or those persons directly responsible for gathering the information, the information provided is to the best of my knowledge and belief, true, accurate, and complete. I am aware that there are significant penalties for submitting false information, including the possibility of fine and imprisonment for knowing violations.

BY: Date:
 Site Inspector

Approved as to form:
 Attorney for American Fork City