

Ent: 326240 - Pg 1 of 6
Date: 5/20/2009 3:41 PM
Fee: \$20.00 CHECK
Filed By: LMO
CALLEEN B PESHELL, Recorder
Tooele County Corporation
For: UNEV PIPELINE

AFTER RECORDING PLEASE RETURN TO:

UNEV Pipeline, LLC
2100 N Redwood Road
Suite 85
Salt Lake City, UT 84116

Line/Project: UNEV
Tract No.: UT-TO-066.1
Parcel No. : 04-070-0-0068

RIGHT-OF-WAY AND EASEMENT

THE STATE OF UTAH

COUNTY OF TOOELE

For and in consideration of TEN DOLLARS and other good and valuable consideration paid to the undersigned (herein styled "**Grantor**", whether one or more), the receipt and sufficiency of which is hereby acknowledged, **Grantor** hereby grants, conveys and warrants to UNEV Pipeline, LLC, a Delaware limited liability company (herein styled "**Grantee**"), whose address is P.O. Box 1326, Artesia, New Mexico, 88211-1326, and its successors and assigns, a non-exclusive, perpetual Right-of-Way and easement (the "Right-of-Way and Easement") to construct, install, maintain, operate, repair, replace, inspect, and protect one (1) nominal twelve inch diameter underground pipeline and associated facilities and appurtenances, for the transportation of oil and gas, and products and by-products thereof, at times or from time to time, as may be necessary or convenient thereto, including but not limited to valves, meters, communication or control facilities, (collectively, the "Facilities") on, over, across and through the "Easement Area" hereinafter defined and located within the following described real property situated in Tooele County, Utah (the "Property"):

A portion of Section 35, Township 1 South, Range 4 West, SLB&M

The Right-of-Way and Easement granted herein shall be seventy-five feet (75') in width during construction, and after the Facilities have been placed in service the rights shall thereafter revert to a twenty foot (20') wide perpetual Right-of-Way and Easement, extending ten feet (10') from each side of the survey line, as such survey line is more particularly described in Exhibit A attached hereto and incorporated herein by reference (herein referred to as the "Easement Area"). To the extent that any discrepancy exists between the legal description and survey set forth on Exhibit A and the actual location of the pipeline, the actual location of the pipeline shall govern, with the Easement Area running parallel to and extending ten feet (10') on each side of the actual location of the centerline of the pipeline as it is buried on Grantor's Property; provided, however that the deviation of the centerline of the pipeline shall not vary from the survey line by more than two feet (2') without the consent of the Grantor and further provided that in the event of deviation of the centerline of the pipeline, Grantee shall be obligated to obtain and provide to Grantor a revised survey locating the centerline of the pipeline and such revised survey line shall be attached to an amendment to this Right-of-Way and Easement, executed by Grantor and Grantee and recorded in the Tooele County Recorder's office to evidence the actual location of such Right-of-Way and Easement. Due to the configuration of the Easement Area with respect to the Grantor's remaining Property and the proposed development of the Property, any deviation from the survey line will result in additional encumbrances of the Grantor's Property, and the Grantee shall compensate Grantor on a prorated basis for the additional area encumbered beyond the survey line.

TO HAVE AND TO HOLD unto Grantee, its successors and assigns, perpetually, with a right of ingress and egress to and from the Easement Area, including the right to use Grantor's roads, for the purposes of constructing, inspecting, repairing, maintaining, operating, repairing, protecting, modifying, and replacing the Facilities, and the removal of same at will, in whole or in part. The rights granted herein

CJR
AA

may be assigned in whole or in part. Should the Facilities be permanently removed or abandoned in place, this Easement Area shall revert to the Grantee or its successors and assigns at no cost to the Grantee.

Grantor may use and enjoy the Easement Area except for the purposes for which such Right-of-Way and Easement is granted; provided that Grantor shall not interfere, disrupt, obstruct or otherwise impede the use of the Right-of-Way and Easement by Grantee, shall not damage or interfere with the Facilities, and shall not construct or maintain, nor permit to be constructed or maintained, any building, structure or obstruction, under, on or over the Right-of-Way and Easement except for the "Authorized Improvements" hereinafter described, and will not change the grade or contour of the Right-of-Way and Easement area without the prior written consent of Grantee, which consent shall not be unreasonably withheld, conditioned or delayed. Grantee hereby agrees to bury the pipeline, exclusive of appurtenances such as valves and meters, to a depth of not less than ~~thirty six (36)~~ ^{forty-eight (48)} inches below the surface of the soil to the top of the pipeline. Prior to any planned installation, repair, or replacement of the Facilities, Grantee shall retain a third party, geotechnical professional, to perform representative compaction tests to determine the existing percentage compaction of the native soils ("Pre-Construction Compaction"), and shall deliver the same to Grantor. Grantee shall restore the excavated area to at least the Pre-Construction Compaction by replacing and compacting all excavated natural materials in lifts not exceeding twelve inches (12"). The above requirements for pretesting will not be required in the case of an emergency, however, the Grantee will be responsible to ensure the described compaction upon completion of any emergency work performed. Notwithstanding the foregoing, Grantee shall use commercially reasonable efforts to compact each 12" lift of any excavation to achieve 95% Standard Proctor Density (ASTM D-698). If, after using commercially reasonable efforts to achieve 95% Standard Proctor Density compaction, the post-construction compaction for a given 12" lift equals or exceeds the Pre-Construction Compaction, Grantee shall have no further obligation to perform compaction on that 12" lift and may proceed with the next 12" lift. Grantee shall retain a third party, geotechnical professional, to perform compactions tests to determine the compaction of each 12" lift of the backfill of any excavated area and shall provide Grantor or Grantor's engineer personnel with copies of such compaction tests as they are performed. Grantee shall permit Grantor's engineering personnel, at Grantor's expense, to perform quality assurance testing of the compaction during the course of construction, so long as such testing does not interfere with or otherwise delay Grantee's installation of the pipeline. Grantee shall also allow the Grantor's engineering personnel, at Grantor's expense and so long as it does not delay backfilling, to collect survey information with respect to alignment and grade prior to backfilling of the trench. Grantor reserves the right to improve the Easement Area and to maintain thereon, crops, pastures, landscaping, sprinkler systems, fences, driveways, roads, streets, curbs, gutters, storm drain facilities, street lights, sidewalks and parking areas, including improvements thereof consisting of concrete, asphalt and other hard surfaces, as well as routine utility crossings so long as the required separations (24" minimum) are maintained between the utilities and the Facilities (all of the foregoing herein referred to as the "Authorized Improvements"). Grantee agrees, at its sole cost and expense to reasonably restore to its or their prior condition or to pay for the restoration of or damages to any and all of the Authorized Improvements arising out of the construction, maintenance and operation of the Facilities. In the event that Grantor or its successors and assigns is required to commence suit to collect such costs and/or damages, the prevailing party shall be entitled to the payment of attorney fees and costs in obtaining a judgment for such award and collecting the same.

✓
forty-eight
(48)
CJR
JA

The terms, conditions and provisions hereof shall be construed under and shall be enforceable in accordance with the laws of the State of Utah, shall run with the land and extend to and be binding upon the heirs, executors, administrators, personal representatives, successors and assigns of the parties hereto.

It is hereby understood that the party securing this grant in behalf of Grantee is without authority to make any covenant or agreement not herein expressed.

CJR
JA

IN WITNESS WHEREOF, Grantee has executed this Right-of-Way and Easement as of the 3rd day of April, 2009.

GRANTEE:

UNEV Pipeline, LLC
a Delaware limited liability company

By: John L. Fielder
John L. Fielder
Its: Right-of-Way Project Supervisor

Limited Liability Company Acknowledgement

THE STATE OF UTAH)
 :SS
COUNTY OF DAVIS)

On this 3rd day of April, 2009, personally appeared before me, John L. Fielder, whose identity is personally known to me (or proved on the basis of satisfactory evidence) and who by me duly sworn (or affirmed), did say he is a Right-of-Way Project Supervisor of UNEV Pipeline, LLC, a Delaware limited liability company and said documents was signed by him in behalf of said limited liability company, and said John L. Fielder acknowledged to me that said company executed the same.

Deanna L. Stookey
Notary Public in and for _____ County
State of _____
My Commission Expires _____



CJR
MA

IN WITNESS WHEREOF, Grantor has executed this Right-of-Way and Easement as of the 3rd day of April, 2009.

GRANTOR:

Beaver Creek Investments, L.C., a Utah limited liability company as to an undivided 18.53% interest

By: Christopher F. Robinson
Christopher F. Robinson
Its: Manager

Uintah Land Company, L.C., a Utah limited liability company as to an undivided 81.47% interest

By: Christopher F. Robinson
Christopher F. Robinson
Its: Manager

Limited Liability Company Acknowledgement

THE STATE OF UTAH)
) :ss
COUNTY OF DAVIS)

On this 3rd day of April, 2009 personally appeared before me Christopher F. Robinson, whose identity is personally known to me (or proved on the basis of satisfactory evidence) and who by me duly sworn (or affirmed), did say he is a Manager of Beaver Creek Investments, L.C., a Utah limited liability company, and a Manager of Uintah Land Company, L.C., a Utah limited liability company, said document was signed by him in behalf of said limited liability companies, and said Christopher F. Robinson acknowledged to me that said companies executed the same.

Deanna L. Stookey
Notary Public in and for Davis County

State of Utah

My Commission Expires 8-8-2010

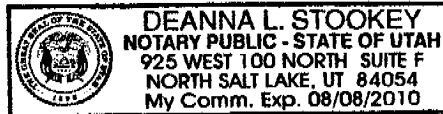

CFR

TRACT NO. UT-TO-066.1			
OWNER BEAVER CREEK INVESTMENTS 04-070-0-0068	STATION TO STATION 0+00.00 - 9+60.80	FEET - RODS 960.80 - 58.23	PERMANENT EASEMENT 0.441 ACRES
			TEMPORARY WORK SPACE 1.213 ACRES
			ADDITIONAL TEMPORARY WORK SPACE 0.014 ACRES

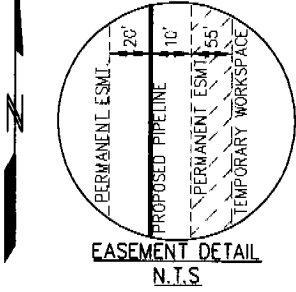

SECTION 35
T1S, R4W S.L.B. & M.

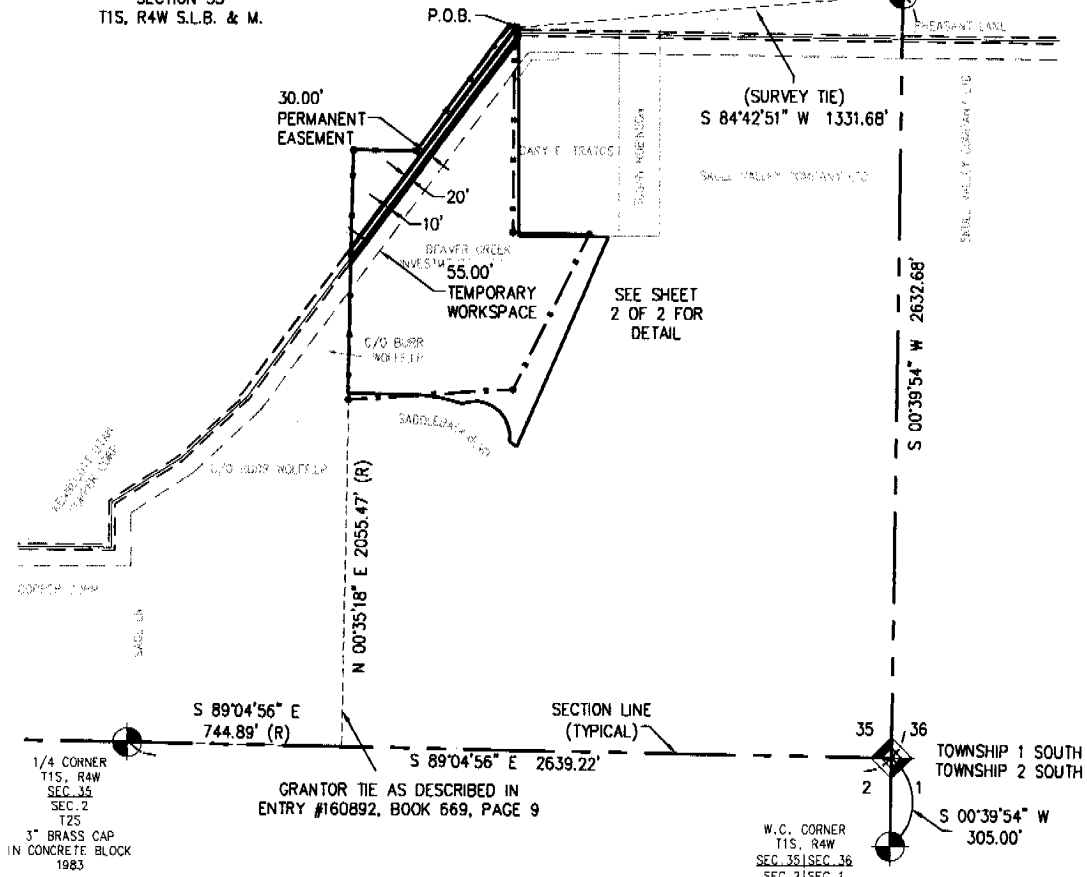

PERMANENT EASEMENT DESCRIPTION

A 30.00 FOOT WIDE PERMANENT EASEMENT ACROSS A PARCEL OF LAND DESCRIBED IN DEED TO BEAVER CREEK INVESTMENTS AND RECORDED IN ENTRY #160892, BOOK 669, PAGE 9 IN THE OFFICE OF THE TOOELE COUNTY RECORDER, LOCATED IN SOUTHEAST ONE-QUARTER OF SECTION 35, TOWNSHIP 1 SOUTH, RANGE 4 WEST OF THE S.L.B. & M., COUNTY OF TOOELE, STATE OF UTAH. SAID 30.00 FOOT WIDE EASEMENT BEING 20.00 FEET ON THE NORTH SIDE AND 10.00 FEET ON THE SOUTH SIDE OF THE PROPOSED PIPELINE AS SHOWN HEREON. SAID PERMANENT EASEMENT BEING BOUNDED WITHIN THE LANDS OWNED BY THE PARTIES NAMED HEREON.

NOTES:

1. THE PROPERTY LINES DEPICTED HEREON ARE APPROXIMATE. THEY ARE BASED UPON RECORD DESCRIPTIONS, DIGITIZED ASSESSOR MAPS AND OTHER DATA. THIS EXHIBIT A IS NOT TO BE RELIED UPON FOR THE ESTABLISHMENT OF FENCES, FUTURE IMPROVEMENTS, OR CONVEYANCES.
2. ALL BEARINGS AND DISTANCES SHOWN HEREON ARE BASED UPON UTM 12, NAD 83 GRID.
3. THIS EXHIBIT WAS PREPARED WITHOUT THE BENEFIT OF A TITLE COMMITMENT. THE PARCEL(S) SHOWN HEREON BEING SUBJECT TO ANY AND ALL EASEMENTS RIGHTS OF WAY, VARIANCES OR AGREEMENTS OF RECORD.

LEGEND

- MONUMENT FOUND AS DESCRIBED
- ◆ CALCULATED CORNER POSITION
- P.O.B. POINT OF BEGINNING
- P.O.T. POINT OF TERMINUS
- FOUND FENCE CORNER
- (R) RECORD INFORMATION

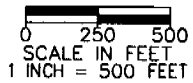
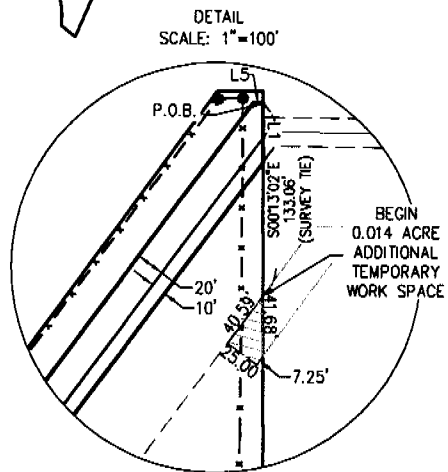
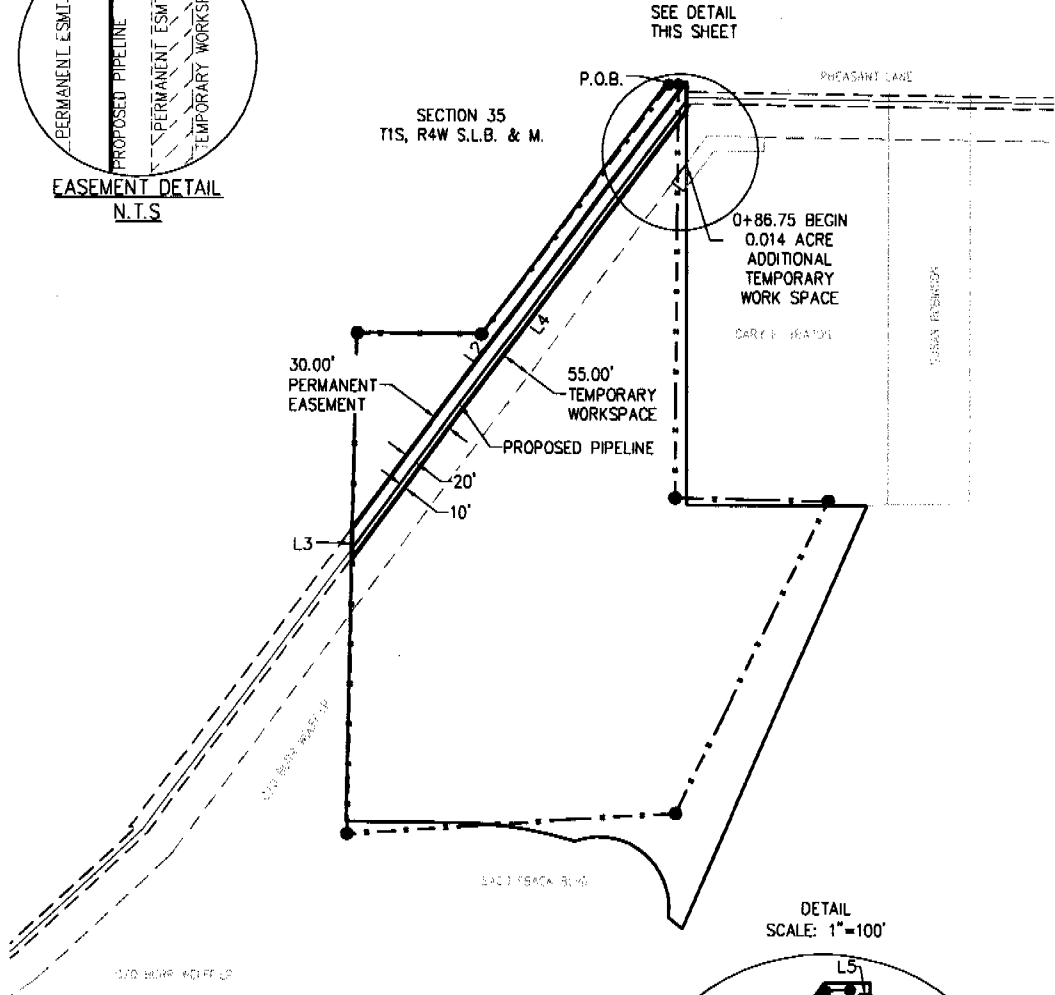
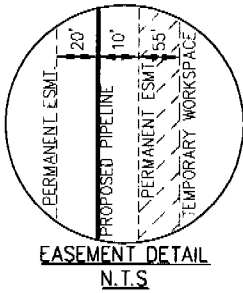

EXHIBIT A BEAVER CREEK INVESTMENTS 04-070-0-0068 SECTION 35, TOWNSHIP 1 SOUTH, RANGE 4 WEST OF THE S.L.B. & M.		
DRAWN BY: BLB	REV: 03/11/09	DATE: 07/10/08
SHEET: 1 OF 2	TOOELE COUNTY, UTAH	
34 VAN CORDON ST., STE. 200, LAKEWOOD, CO 80226 303-296-9840	DRAWING NUMBER UT-TO-066.1	

*CHR
9/17*

TRACT NO. UT-TO-066.1			
OWNER	STATION TO STATION	FEET - RODS	
BEAVER CREEK INVESTMENTS 04-070-0-0068	-	-	PERMANENT EASEMENT 0.661 ACRES
	-	-	TEMPORARY WORK SPACE 1.213 ACRES
	-	-	ADDITIONAL TEMPORARY WORK SPACE 0.014 ACRES
	-	-	



LINE	BEARING	DISTANCE
L1	S 00°13'02" E	41.38'
L2	S 36°38'34" W	961.44'
L3	N 01°03'38" E	51.56'
L4	N 36°38'34" E	948.85'
L5	S 89°22'51" E	6.41'

- LEGEND**
- ◆ MONUMENT FOUND AS DESCRIBED
 - ◆ CALCULATED CORNER POSITION
 - P.O.B. POINT OF BEGINNING
 - P.O.T. POINT OF TERMINUS
 - FOUND FENCE CORNER
 - (R) RECORD INFORMATION

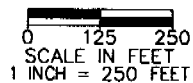

EXHIBIT A
BEAVER CREEK INVESTMENTS
 04-070-0-0068
 SECTION 35, TOWNSHIP 1 SOUTH,
 RANGE 4 WEST OF THE S.L.B. & M.

DRAWN BY: BLB	REV: 03/11/09	DATE: 07/10/08
SHEET: 2 OF 2	TOOELE COUNTY, UTAH	
34 VAN CORDON ST., STE. 200, LAKEWOOD, CO 80228 303-298-9645		DRAWING NUMBER UT-TO-066.1

CJR
MA