

12582055
07/25/2017 04:25 PM \$0.00
Book - 10581 Pg - 2473-2541
GARY W. OTT
RECORDER, SALT LAKE COUNTY, UTAH
TAYLORSVILLE CITY
2600 TAYLORSVILLE BLVD
TAYLORSVILLE UT 84118-2208
BY: KRP, DEPUTY - WI 69 P.

WHEN RECORDED RETURN TO:

City of Taylorsville
Attn: Cheryl Cottle, City Recorder
2600 West Taylorsville Blvd.
Taylorsville, UT 84129

**DEVELOPMENT AGREEMENT
FOR THE SUMMIT LIFE PLAN COMMUNITIES, LLC CONTINUING CARE
RETIREMENT COMMUNITY PROJECT**

THIS DEVELOPMENT AGREEMENT (the "Agreement") is entered into this 25 day of July, 2017, by and between SUMMIT LIFE PLAN COMMUNITIES, LLC, a Delaware corporation ("Developer") and the CITY OF TAYLORSVILLE, a municipality and political subdivision of the State of Utah (the "City"). Developer and the City are hereinafter sometimes referred to individually as a "Party" or collectively as the "Parties."

RECITALS

A. Developer has entered into agreements for the purchase of a total of approximately 86.55 acres of real property located within the boundaries of the City as more particularly described in Exhibit A-1 (the "Retirement Community Property"); approximately 5 acres of real property that will be dedicated as public right of way for future roads; and approximately 14 acres of real property located within the boundaries of the City as more particularly described in Exhibit A-2 (the "Future Development Parcel", and, together with the Retirement Community Property, the "Properties").

B. Developer, in conjunction and cooperation with the current owners of their respective properties, has made application to the City for a general plan map amendment, rezone or map amendment and zoning text amendment to assign to the site specific development district designation for mixed residential and commercial uses ("SSD-X-Bennion Point") to both the Retirement Community Property and the Future Development Parcel for the purpose of developing a continuing care retirement community on the Retirement Community Property (the "Retirement Community Project") and a commercial project on the Future Development Parcel (together with the Retirement Community Project, the "Project").

C. The intent of this Agreement is to facilitate the development of both the Retirement Community Property and the Future Development Parcel in accordance with the site-specific land uses allowed and development standards adopted by the City as part of the SSD-X-Bennion Point zoning district to provide for a creative development with unique and unusual characteristics for the benefit of all Parties.

D. The City, acting pursuant to its authority under UTAH CODE ANN. §§ 10-9a-101, *et seq.*, has made certain determinations with respect to the Retirement Community Property, the Future Development Parcel and the Project, and, in the exercise of its legislative discretion, has

elected to process and approve this Agreement after all necessary public hearings and procedures have been conducted.

AGREEMENT

NOW, THEREFORE, in consideration of the mutual covenants contained herein, and other good and valuable consideration, the receipt and sufficiency of which is hereby acknowledged, the Parties hereby agree as follows:

1. **Incorporation of Recitals.** The Recitals and Exhibits are hereby incorporated by reference as part of this Agreement.

2. **Conditions Precedent.**

2.1. **Closing of Property Transactions.** As a condition precedent to the obligations of the Parties hereunder, this Agreement is contingent upon and shall only become effective at such time, and in the event that, Developer closes on the sale of both of the Properties. In the event that either of those sales fail to close, this Agreement shall be of no further force and effect and both the Retirement Community Property and the Future Development Parcel shall revert to the pre-existing, underlying zoning districts in which the Retirement Community Property and the Future Development Parcel are currently located.

2.2. **Approval of Zoning by City Council.** As a second and additional condition precedent to the obligations of the Parties hereunder, this Agreement is contingent upon and shall only become effective at such time, and in the event that, the Taylorsville City Council, in the independent exercise of its legislative discretion, elects to approve the proposed rezoning of both the Retirement Community Property and the Future Development Parcel to the SSD-X-Bennion Point Zoning District. This Agreement is not intended to and does not affect or in any way bind or supersede the independent exercise of legislative discretion by the City Council in deciding whether to approve or deny the application for the rezoning of the Retirement Community Property and the Future Development Parcel.

3. **Retirement Community Property Concept Plan.** A concept plan generally depicting the location of proposed land uses and structures, major streets and configurations of the Retirement Community Property portion of the Project is attached in the form of Exhibit B, which is hereby incorporated by this reference. The approval of the concept plan as part of this Agreement satisfies the requirement of the Taylorsville City Code (the "Code") for a development plan as part of the SSD-X-Bennion Point Zoning District for the Retirement Community Property portion of the Project.

4. **Land Uses and Concept Plan for the Future Development Parcel.** Subject to the conditions precedent in Section 2 of this Agreement, the Future Development Parcel shall be assigned the "SSD-X-Bennion Point" zoning district designation, but the land uses, structures, densities, major streets and other matters that would typically be set forth in a concept plan for the development of the Future Development Parcel shall be determined at such time as a more specific development plan is proposed and approved by the City for the Future Development

Parcel. The Parties understand and agree that a concept plan for the Future Development Parcel may propose an expansion of the uses and concept plan approved for the Retirement Community Property, but pursuant to the provisions of Section 13.19.010(C) and (E) of the Code, the approval of any additional land uses beyond those allowed as part of the Retirement Community Property as set forth in Exhibit C and described in Section 5.1 below, a concept plan including any additional commercial uses and site specific development standards for such uses on the Future Development Parcel shall require and be contingent upon the favorable exercise of future legislative discretion by the City Council following all required notice and public hearings before the Planning Commission and City Council.

5. Project-Specific Development Standards.

5.1. Specific-Development Standards. The purpose of the SSD-X-Bennion Point Zoning District is to provide for site-specific development standards in order to allow for the efficient and creative development of property with unique or unusual characteristics. Specific land uses allowed, development standards and regulations for the Retirement Community Property portion of the SSD-X-Bennion Point Zoning District have been approved pursuant to the provisions of Section 13.19.010 of the Code and are attached hereto as Exhibit C and incorporated by this reference. Developer shall develop the Retirement Community Portion of the Project generally in accordance with the concept plan attached as Exhibit B and in compliance with the site-specific land uses allowed and the development standards as contained in Exhibit C. Developer may also develop the Future Development Parcel in accordance with the site specific land uses allowed and development standards set forth in Exhibit C subject to the approval of a concept plan for the Future Development Parcel as described in Section 4 above; however, the Parties understand and agree that any other potential commercial or additional uses and site specific development standards for such additional uses on the Future Development Parcel portion of the Project shall be submitted and approved following the process set forth in Section 4 above and, upon approval, shall be incorporated as an amendment to Exhibit C. Developer further agrees to install fencing and landscaping adjacent to existing residential land uses within twenty four (24) months of the date of this Agreement.

5.2. Amendments to Concept Plan and Specific SSD-X Development Standards. The Parties understand and agree that the concept plan attached as Exhibit B is a general depiction of building locations, sizes and uses and that more detailed and specific site plans shall be submitted for approval before any actual construction may begin on any portion of the Retirement Community Property as part of the Project, which may deviate or vary slightly or in ways that are irrelevant to planning considerations from what is depicted in Exhibit B to this Agreement or which represent logical development of the details depicted on Exhibit B. In the event that Developer or the successor owner of the Retirement Community Property desires to further modify Exhibit B, it shall submit a request to the Community Development Director of the City ("CDD"), who may approve minor modifications or amendments in the development of the Project as depicted in Exhibit B. Without limiting the scope of what constitutes a minor modification or amendment, the following shall be presumed to constitute a minor modification or amendment: (a) an increase of less than five percent (5%) in the total overall square footage in the entire Continuing Care Retirement Community Property; (b) alteration of the sizes or types of units in each Phase of the Continuing Care Retirement Community that does not cause the

total overall square footage to exceed the five percent (5%) threshold set forth in (a); (c) alteration of the exterior design and improvements to the buildings within setbacks; (d) any decrease in hardscape and increase in landscaping; and (e) variations in the heights of buildings between five (5) and seven (7) stories provided the modification is consistent with the height standards in Section 13.38.4.C of the SSD-X Bennion Point land use regulations attached as Exhibit C. For avoidance of doubt, alteration of the size, type or number of units in any Phase of the entire Continuing Care Retirement Community Property that falls within the presumptions set forth in the previous sentence shall constitute a minor modification or amendment. Any amendments to this Agreement that the CDD determines to be major amendments to Exhibit B, as determined by the CDD, shall be referred to the Planning Commission for their review and approval. Any proposed amendment to the specific SSD-X-Bennion Point development standards and regulations in Exhibit C including, but not limited to, changes in road alignment, height of buildings, setbacks, density and uses of property shall be regarded as a major amendment that shall require either Planning Commission or City Council approval, depending on whether the proposed amendment is only to the Concept Plan or to the Specific Development Standards and Regulations attached as Exhibit C. Except as provided above, the CDD shall have the discretion to determine what constitutes a minor or major amendment and may elect to seek approval of the Planning Commission and/or City Council, as applicable, in his or her discretion. Any decision of the CDD approving or denying a request for a minor modification in Exhibit B, or a decision as to whether a proposed modification is a major amendment that requires Planning Commission or City Council approval, as applicable, is a land use decision that may be appealed under the provisions of §13.34.010 of the Code.

6. **Approval Process for Development Applications.** The City shall process applications for development of the Project in accordance with the provisions of the Code. Developer expressly acknowledges and agrees that nothing in this Agreement shall be deemed to relieve it of the obligation to comply with all of the applicable requirements for approval of preliminary and final subdivision plats, or preliminary and final site plans, as applicable, for the proposed development of the Project consistent with the terms and conditions of this Agreement and the applicable provisions of the Code.

7. **Phasing.** Developer may develop the Project in several phases as market conditions dictate as long as each phase provides for the logical extension of infrastructure and utilities as approved by the City and in compliance with the terms of this Agreement and the applicable provisions of the Code. All phasing decisions for the Retirement Community Property portion of the Project shall constitute minor modifications. A preliminary phasing plan for the Retirement Community Property is attached hereto and incorporated by this reference as Exhibit D. Developer agrees to proceed with construction of the Retirement Community Property portion of the Project with reasonable diligence consistent with Exhibit D. A phasing plan for the Future Development Parcel portion of the Project shall be submitted and approved along with the land uses, concept plan and site specific development standards as set forth in Section 4 above.

8. **Payment of Fees.**

8.1. **Development Application and Review Fees.** Developer shall pay to the City all of the fees, including, but not limited to, application fees, impact fees and connection fees for

review and approval of development of any and all phases of the Project in the amounts set forth in the City's Consolidated Fee Schedule, a copy of which is attached as Exhibit E and incorporated by this reference. Pursuant to the provisions of §3.16.080 of the Code, the City Council hereby makes a determination that there is a prevailing public interest in allowing deferral of the payment of fees for final subdivision and final site plan approval on a phase by phase basis for the Project.

8.2. Other Fees. The City may charge other fees in existence as of the date of this Agreement, including, without limitation, standard building permit review, and inspection fees for improvements to be constructed on improved parcels that are generally applicable to other developments within the City. The Project shall not be subject to new fees and charges imposed by the City after the date of this Agreement.

8.3. Reservation of Right to Challenge Fees. Notwithstanding any provision of this Agreement, the Developer does not waive Developer's rights under any applicable law to challenge the reasonableness or legality of the amount or imposition of any fees.

9. Vested Rights.

9.1. Vested Rights. Developer shall have the vested right to have preliminary and final subdivision plats, or preliminary and final site plans, as applicable, approved and to develop and construct the Project in accordance with and subject to compliance with the terms and conditions of this Agreement, the SSD-X-Bennion Point Zoning District and other applicable provisions of the Code, and further subject to compliance with the provisions of Sections 4 and 5.1 with respect to any additional commercial uses and the approval of a concept plan for the Future Development Parcel. Pursuant to the provisions of §13.19.010(H) of the Code, if no substantial construction has been initiated as part of the Project within two (2) years of the date of this Agreement plus any period of force majeure, the City may consider rezoning the property to revert back to the zoning districts that existed prior to the approval of the SSD-X-Bennion Point Zoning District. To the extent that there is any conflict between the text portion of this Agreement and the Exhibits, the more specific language or description, as the case may be, shall control. Where any conflict or ambiguity exists between the provisions of the Code and this Agreement (including the Exhibits to this Agreement), this Agreement shall govern. Notwithstanding the foregoing, the rights vested as provided in this Agreement are not exempt from the application of the Code and to subsequently enacted ordinances to the extent that would impair the City's reserved legislative powers in Section 9.2.

9.2. Reserved Legislative Powers. The Parties acknowledge that the City is restricted in its authority to limit its police power by contract and that the limitations, reservations and exceptions set forth herein are intended to reserve to the City those police powers that cannot be so limited. Notwithstanding the retained power of the City to enact such legislation under the police powers, such legislation shall only be applied to modify any development standards that are applicable to the Project under the terms of this Agreement based upon the policies, facts and circumstances meeting the compelling, countervailing public interest exception to the vested rights doctrine of the State of Utah. Any such proposed legislative changes shall be of general application to all development activity in the City; and, unless the

City declares an emergency, Developer shall be entitled to prior written notice and an opportunity to be heard with respect to any proposed change and its applicability to the Project under the compelling, countervailing public interest exception to the vested rights doctrine.

10. Infrastructure and the Provision of Municipal Services.

10.1. Construction of Necessary Infrastructure to Service the Project. Except as otherwise specifically identified as a City responsibility in Exhibit F, which is attached hereto and incorporated by this reference (which the City specifically agrees to construct or cause to be constructed at no cost to Developer), Developer shall have the obligation to construct or cause to be constructed and installed all of the public or private infrastructure, including, but not limited to, roads and utilities, which are located on and necessary to service any portion of the Retirement Community Property and Future Development Parcel, as applicable, as part of the Project, which are the subject of an application for development approval, and any off-site improvements necessary to connect to existing utilities.

10.2. Third Party Service Providers. The Parties understand and acknowledge that the City will only be the service provider of the roads and storm drainage facilities to service the Project. Developer shall be responsible to obtain the approval and incur the costs of constructing any off-site and on-site infrastructure and improvements from third party service providers including, but not limited to, Rocky Mountain Power, Questar Gas and the Taylorsville-Bennion Improvement District that are necessary to service any portion of the Retirement Community Property and Future Development Parcel, as applicable, as part of the Project. The City shall reasonably cooperate, as necessary, in seeking approval and permits from third party service providers.

10.3. Maintenance of Private Roads and Improvements. Developer shall have the duty to maintain all private roads and areas designated as such on subdivision plats that are located within that portion of the Project constructed on the Retirement Community Property.

10.4. Landscaping and Maintenance Plan for Median. Developer shall have the responsibility to install and maintain, including, but not limited to, irrigation, regular pruning and replacement of dead materials, the landscaping in the median of the boulevard of the main access to the Project from 6200 South Street in the City as more fully described and depicted in Exhibit F. Developer shall submit a landscape and maintenance plan that complies with the standards set forth in Exhibit C for approval by the Planning Commission at the time of and in conjunction with Phase 1 of the Project. Developer may provide for maintenance of that common landscaped area by the formation of an assessment area, a common area maintenance plan or other acceptable form of private maintenance agreement, which shall be prepared by Developer and submitted for approval by the City.

11. Term of Agreement. The term of this Agreement (the "Term") shall be for a period of fifteen (15) years following the date of its execution by all Parties, unless it is terminated earlier or its Term is modified by written amendment to this Agreement, but the terms of this Agreement shall continue to be effective as to applications that have been submitted and development that has occurred within the Project notwithstanding the termination of this

Agreement. Developer shall have the right to renew the Term with respect to the Retirement Community Project for five (5) additional years if it has made significant progress in developing the Retirement Community Project.

12. Successors and Assigns.

12.1. Binding Effect. This Agreement shall be binding upon all successors and assigns of Developer in the ownership or development of any portion of the Retirement Community Property, the Future Development Parcel and the Project.

12.2. Assignment. Neither this Agreement nor any of its provisions, terms or conditions may be assigned to any other party, individual or entity without assigning the rights as well as the responsibilities under this Agreement without the prior written consent of the City, which consent shall not be unreasonably withheld, conditioned or delayed. Under this Agreement, the rights with respect to the Retirement Community Property and Future Development Parcel may be separately assigned to different persons or entities subject to approval by the City as set forth in this Section 12.2. Any such request for assignment may be made by letter addressed to the City as provided herein and the prior written consent of the City may also be evidenced by letter from the City to Developer or its successors or assigns. The assignment of the Future Development Parcel portion of the Project shall require the assignee to sign a form of acknowledgement and consent agreeing to be bound by the terms of this Agreement and, to the extent then finally approved, any land uses, concept plan, amendments to the site specific development standards set forth in Exhibit C and phasing plan approved by the City Council pursuant to the legislative process described in Sections 4 and 5.1 above for the Future Development Parcel portion of the Project.

13. Default.

13.1. Notice. If Developer or the City fail to perform their respective obligations hereunder or to comply with the terms hereof, the party believing that a default has occurred shall provide notice to the other party as provided herein. If the City believes that the default has been committed by Developer, then the City shall also provide a courtesy copy of the notice to Developer.

13.2. Contents of the Notice of Default. The Notice of Default shall:

13.2.1. Claim of Default. Specify the claimed event of default;

13.2.2. Identification of Provisions. Identify with particularity the provisions of any applicable law, rule, regulation or provision of this Agreement that is claimed to be in default;

13.2.3. Specify Materiality. Identify why the default is claimed to be material;
and

13.2.4. Optional Proposed Cure. If the City chooses, in its discretion, propose a method and time for curing the default which shall be of no less than sixty (60) days duration.

13.3. Meet and Confer. Upon the issuance of a Notice of Default, the Parties shall meet within ten (10) business days and confer in an attempt to resolve the issues that are the subject matter of the Notice of Default.

13.4. Remedies. If, after meeting and conferring, the Parties are not able to resolve the default, then the Parties may have the following remedies:

13.4.1. Legal Remedies. The rights and remedies available at law and in equity, including, but not limited to injunctive relief, specific performance and termination, but not including damages or attorney's fees.

13.4.2. Enforcement of Security. The right to draw on any security posted or provided in connection with the Project and relating to remedying of the particular default.

13.4.3. Withholding Further Development Approvals. The right to withhold all further reviews, approvals, licenses, building permits and/or other permits for development of the Project on those properties owned by the defaulting party.

13.5. Public Meeting. Before any remedy in Section 12.4 may be imposed by the City, the party allegedly in default shall be afforded the right to attend a public meeting before the Council and address the Council regarding the claimed default.

13.6. Emergency Defaults. Anything in this Agreement notwithstanding, if the Council finds on the record that a default materially impairs a compelling, countervailing interest of the City and that any delays in imposing such a default would also impair a compelling, countervailing interest of the City then the City may impose the remedies of Section 12.4 without meeting the requirements of Section 12.5. The City shall give Notice to Developer and/or any applicable successor or assign of any public meeting at which an emergency default is to be considered and the allegedly defaulting party shall be allowed to address the Council at that meeting regarding the claimed emergency default.

13.7. Extended Cure Period. If any default cannot be reasonably cured within sixty (60) days then such cure period may be extended as needed, by agreement of the Parties for good cause shown, so long as the defaulting party is pursuing a cure with reasonable diligence.

13.8. Cumulative Rights. The rights and remedies set forth herein shall be cumulative.

13.9. Force Majeure. All time periods imposed or permitted pursuant to this Agreement shall automatically be extended and tolled for: (a) period of any and all moratoria imposed by the City or other governmental authorities in any respect that materially affects the development of the Project; or (b) by events reasonably beyond the control of Developer

including, without limitation, inclement weather, war, strikes, unavailability of materials at commercially reasonable prices, and acts of God, but which does not include financial condition of the Developer or its successors.

14. Notices. Any notices, requests and demands required or desired to be given hereunder shall be in writing and shall be served personally upon the Party for whom intended or if mailed be by certified mail, return receipt requested, postage prepaid to such Party at its address shown below:

To Summit Life Plan Communities, LLC:

Summit Life Plan Communities, LLC
Attn: Christian Gardner, Manager
Gardner Taylorsville, L.C.
201 South Main St., Suite 2000
Salt Lake City, Utah 84111

With a copy to:

Parr Brown Gee & Loveless
Attn: David Gee
101 S. 200 E. Suite 700
Salt Lake City, Utah 84111

To the City of Taylorsville:

Taylorsville City
Attn: John Taylor, City Administrator
2600 West Taylorsville Blvd.
Taylorsville, Utah 84129

With a copy to:

Taylorsville City Attorney's Office
Attn: Tracy S. Cowdell
2600 West Taylorsville Blvd.
Taylorsville, Utah 84129

Any Party may change its address or notice by giving written notice to the other Parties in accordance with the provisions of this Section.

GENERAL TERMS AND CONDITIONS

1. Agreement to Run with the Land. This Agreement shall be recorded in the Office of the Salt Lake County Recorder against the Developer Retirement Community Property and the Commercial Property and is intended to and shall be deemed to run with the land and shall be

binding on all successors in the ownership and development of any portion of the Developer Retirement Community Property and the Commercial Property.

2. **Entire Agreement.** This Agreement, together with the Exhibits hereto, integrates and constitutes all of the terms and conditions pertaining to the subject matter hereof and supersedes all prior negotiations, representations, promises, inducements, or previous agreements between the Parties hereto with respect to the subject matter hereof. Any amendments hereto must be in writing and signed by the respective Parties hereto.

3. **Headings.** The headings contained in this Agreement are intended for convenience only and are in no way to be used to construe or limit the text herein.

4. **Non-Liability of City Officials or Employees.** No officer, representative, agent, or employee of the City shall be personally liable to Developer, or any successor-in-interest or assignee of Developer, in the event of any default or breach by the City or for any amount which may become due to Developer, or its successors or assignees, for any obligation arising out of the terms of this Agreement.

5. **No Third-Party Rights.** The obligations of the Parties set forth in this Agreement shall not create any rights in or obligations to any persons or parties other than to the City and Developer. The City and Developer alone shall be entitled to enforce or waive any provisions of this Agreement to the extent that such provisions are for their benefit.

6. **Severability.** Should any portion of this Agreement for any reason be declared invalid or unenforceable, the invalidity or unenforceability of such portion shall not affect the validity of any of the remaining portions, and the same shall be deemed in full force and effect as if this Agreement had been executed with the invalid portions eliminated.

7. **Waiver.** No waiver of any of the provisions of this Agreement shall operate as a waiver of any other provision regardless of any similarity that may exist between such provisions, nor shall a waiver in one instance operate as a waiver in any future event. No waiver shall be binding unless executed in writing by the waiving Party.

8. **Survival.** All agreements, covenants, representations, and warranties contained herein shall survive the execution of this Agreement and shall continue in full force and effect throughout the term of this Agreement.

9. **Public Information.** The Parties understand and agree that all documents related to this agreement will be public documents, as provided in UTAH CODE ANN. § 63G-2-101, *et seq.*

10. **Governing Law.** This Agreement and the performance hereunder shall be governed by the laws of the State of Utah.

11. **Counterparts.** This Agreement may be executed in multiple counter-parts which shall constitute one and the same document.

(Signatures begin on following page)

IN WITNESS WHEREOF, this Agreement has been executed by the City of Taylorsville, acting by and through the Taylorsville City Council, Salt Lake County, State of Utah, pursuant to Resolution No. 15-29, authorizing such execution, and by a duly authorized representative of Developer as of the above-stated date.

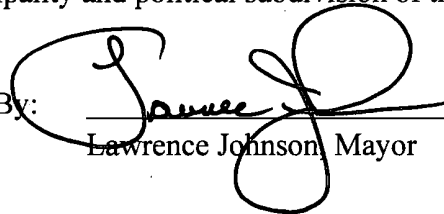

CITY OF TAYLORSVILLE,
a Utah municipality and political subdivision of the State of Utah.

By: 
Lawrence Johnson, Mayor

ATTEST:



Cheryl Cottle, Taylorsville City Recorder

APPROVED AS TO FORM:

City Attorney

SUMMIT LIFE PLAN COMMUNITIES, LLC,
a Delaware limited liability company,
By its Operating Member:

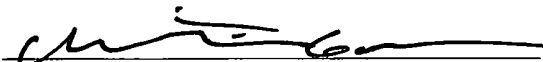
GARDNER TAYLORSVILLE, LLC,
a Utah limited liability company.

By: 
Christian K. Gardner, Manager

STATE OF UTAH)
 :SS.
COUNTY OF SALT LAKE)

On the 12 day of JULY, 2017, personally appeared before me Christian K. Gardner, who being duly sworn, did say that he is the Manager of Gardner Taylorsville, LLC, a Utah limited liability company and the Operating Member of Summit Vista Life Plan Communities, LLC., a Delaware limited liability company, and that the foregoing instrument was signed in behalf of said corporation and said Christian K. Gardner duly acknowledged to me that he executed the same for the purposes therein stated.

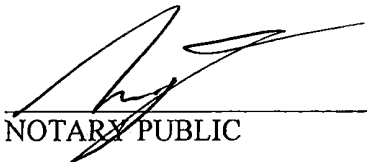
NOTARY PUBLIC

My Commission Expires: 10.16.20



Exhibit "A-1" Retirement Community Property

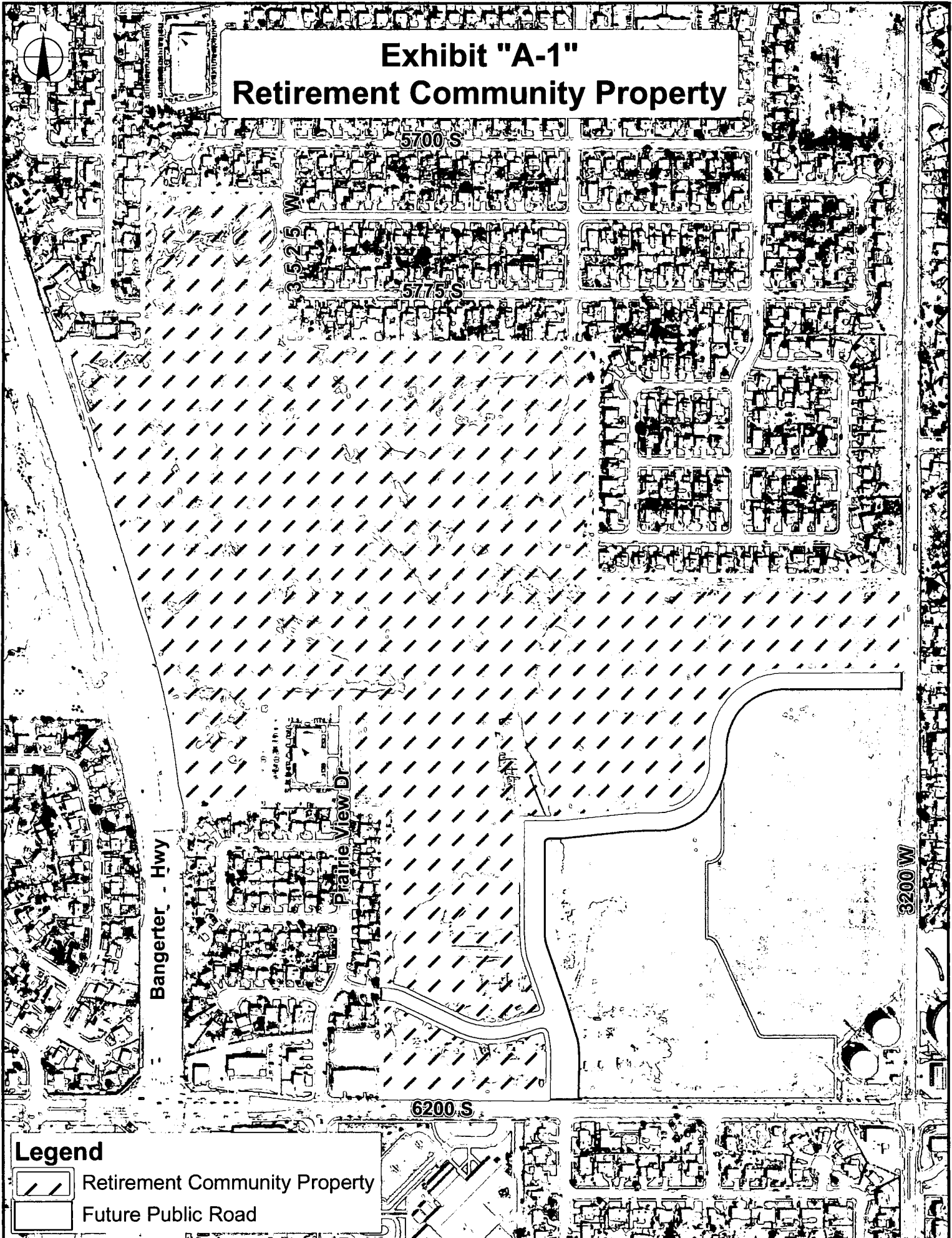

Legend

-  Retirement Community Property
-  Future Public Road

EXHIBIT "A-1"
RETIREMENT COMMUNITY PROPERTY LEGAL DESCRIPTION

A tract of land, situate in the Southeast Quarter of Section 17, Township 2 South, Range 1 West, Salt Lake Base and Meridian:

Beginning at a point on the East Boundary line of Stonewood Subdivision, a residential development in Taylorsville City, Salt Lake County Utah at a point 1821.19 feet North 89°57'49" West along the section line and 438.00 feet North 00°02'11" East from the Southeast corner of said Section 17 and running thence North 00°16'50" East 594.99 feet along the East Boundary line of said Stonewood Subdivision, to the Northeast corner of said subdivision; thence North 89°57'49" West 110.00 feet along the North Boundary line of said subdivision to the East right of way line of 3500 West Street; thence North 00°16'50" East 363.00 feet; thence North 89°57'49" West 321.00 feet; thence South 00°16'50" West 363.00 feet to said North Boundary line; thence North 89°57'49" West 247.33 feet along said North Boundary line to the East right of way line of Bangert Highway; thence three (3) courses along said East right of way line as follows: (1) North 14°07'22" West 84.43 feet to the point of curve of a non-tangent curve whose center point bears South 84°03'56" West; (2) Northerly along the arc of a 2,600.67 foot radius curve to the left a distance of 553.16 feet (Central Angle equals 12°11'12", and Long Chord bears North 12°01'40" West 552.12 feet) ; and (3) North 18°07'16" West 1,040.81 feet to the South Boundary line of Wildwood Estates No. 2, a residential development in Taylorsville City, Salt Lake County Utah; thence North 89°56'25" East 297.76 feet along said South Boundary line to the Southeast corner of said subdivision; thence North 00°06'28" West 527.77 feet along the East Boundary line of said Whitewood Estates No. 2, to the South line of Willow Bay No. 4, a residential development in Taylorsville City, Salt Lake County Utah; thence North 89°57'17" East 467.91 feet along said South Boundary line to the point of curve of a non-tangent curve whose center point bears North 89°56'53" East; thence Southerly along the arc a 110.00 foot radius curve to the left a distance of 41.09 feet (Central Angle equals 21°24'06", and Long Chord bears South 10°45'10" East 40.85 feet) to the point of curve of a non-tangent curve whose center point bears South 68°32'45" West; thence Southerly along the arc a 140.84 foot radius curve to the right a distance of 52.74 feet (Central Angle equals 21°27'13", and Long Chord bears South 10°43'39" East 52.43 feet) ; thence due South 25.50 feet; thence due East 10.00 feet to the West Boundary line of Willow Bay No. 5, a residential development in Taylorsville City, Salt Lake County Utah; thence due South 409.75 feet along said West Boundary line to the Southwest corner of said Willow Bay No. 5; thence North 89°57'26" East 1,073.01 feet along the South Boundary line of said Willow Bay No. 5, and the South Boundary line of Willow Bay No. 6, a residential development in Taylorsville City, Salt Lake County Utah to the West Boundary line of Willow Bay No. 7, a residential development in Taylorsville City, Salt Lake County Utah; thence due South 800.00 feet along said West Boundary line to the Southeast corner of said Willow Bay No. 7; thence North 89°57'26" East 1,054.11 feet along the South Boundary line of said Willow Bay No. 7, and the South Boundary line of Willow Bay No. 9, a residential development in Taylorsville City, Salt Lake County Utah to the West right of way line of 3200 West Street; thence South 00°06'34" East 330.85 feet along said West right of way line; thence South 89°53'26" West 396.32 feet to a point of curvature; thence Southwesterly along the arc of a 265.00 foot radius curve to the left a distance of 415.75 feet (Delta Angle equals 89°53'26" and Long Chord bears South 44°56'43" West 374.41 feet); thence due South 43.62 feet to a point of curvature; thence Southwesterly along the arc of a 170.00 foot radius curve to the right a distance of 264.81 feet (Delta Angle equals 89°15'00" and Long Chord bears South 44°37'30" West 238.84 feet); thence South 89°15'00" West 48.73 feet to a point of curvature; thence Westerly along the arc of a 835.00 foot radius curve to the left a distance of 72.30 feet (Delta Angle equals 04°57'40" and Long Chord bears South 86°46'10" West 72.28 feet); thence South 84°17'20" West 207.36 feet to a point of curvature; thence Westerly along the arc of a 365.00 foot radius curve to the right a distance of 36.38 feet (Delta Angle equals 05°42'40" and Long Chord bears South 87°08'40" West 36.37 feet); thence due West 107.29 feet; thence due South 390.55 feet to a point of curvature; thence Southerly along the arc of a 235.00 foot radius curve to the left a distance of 17.59 feet (Delta Angle equals 04°17'18" and Long Chord bears South 02°08'39" East 17.59 feet); thence South 04°17'18" East 35.96 feet to a point of curvature; thence Southerly along the arc of a 200.00 foot radius curve to the left a distance of 51.46 feet (Delta Angle equals 14°44'34" and Long Chord bears South 11°39'35" East 51.32 feet); thence South 19°01'52" East 163.65 feet to a point of curvature; thence Southwesterly along the arc of a 15.00 foot radius curve to the right a distance of 24.35 feet (Delta Angle equals 93°00'36" and Long Chord bears South 27°28'26" West 21.76 feet); thence South 73°58'43" West 106.68 feet to a point of curvature; thence Westerly along the arc of a 220.23 foot radius curve to the right a distance of 159.47 feet (Delta Angle equals 41°29'21" and Long Chord bears North 85°16'37" West 156.01 feet); thence North 64°31'56" West 214.40 feet to a point of curvature; thence Westerly along the arc of a 210.00 foot radius curve to the left a distance of 92.32 feet (Delta Angle equals 25°11'14" and Long Chord bears North 77°07'33" West 91.57 feet); thence North 89°43'10" West 1.78 feet to the Point of Beginning.

Contains 83.331 acres

Together with:

Beginning on the Northerly right of way line of 6200 South Street at a point 1246.57 feet North 89°57'49" West along the section line and 45.96 feet North 00°02'11" East from the Southeast corner of said Section 17 and running thence North 89°57'49" West 576.29 feet along said Northerly line to the East Boundary line of Prairie View Condominiums, a condominium development in Taylorsville City, Salt Lake County Utah; thence North 00°16'50" East 332.04 feet along said East Boundary line and the East Boundary line of Stonewood Subdivision, a residential development in Taylorsville City, Salt Lake County Utah; thence South 89°43'10" East 1.78 feet to a point of curvature; thence Easterly along the arc of a 150.00 foot radius curve to the right a distance of 65.94 feet (Delta Angle equals 25°11'14" and Long Chord bears South 77°07'33" East 65.41 feet); thence South 64°31'56" East 214.40 feet to a point of curvature; thence Easterly

along the arc of a 280.23 foot radius curve to the left a distance of 202.92 feet (Delta Angle equals $41^{\circ}29'21''$ and Long Chord bears South $85^{\circ}16'36''$ East 198.52 feet); thence North $73^{\circ}58'43''$ East 96.48 feet to a point of curvature; thence Southeasterly along the arc of a 15.00 foot radius curve to the right a distance of 25.01 feet (Delta Angle equals $95^{\circ}32'56''$ and Long Chord bears South $58^{\circ}14'49''$ East 22.22 feet) to a point of compound curvature; thence Southerly along the arc of a 455.82 foot radius curve to the right a distance of 88.26 feet (Delta Angle equals $11^{\circ}05'37''$ and Long Chord bears South $04^{\circ}55'33''$ East 88.12 feet); thence South $00^{\circ}37'16''$ West 136.44 feet to the Point of Beginning.

Contains 3.244 Acres

Contains 86.555 Acres Total

Exhibit "A-2" Future Development Parcel

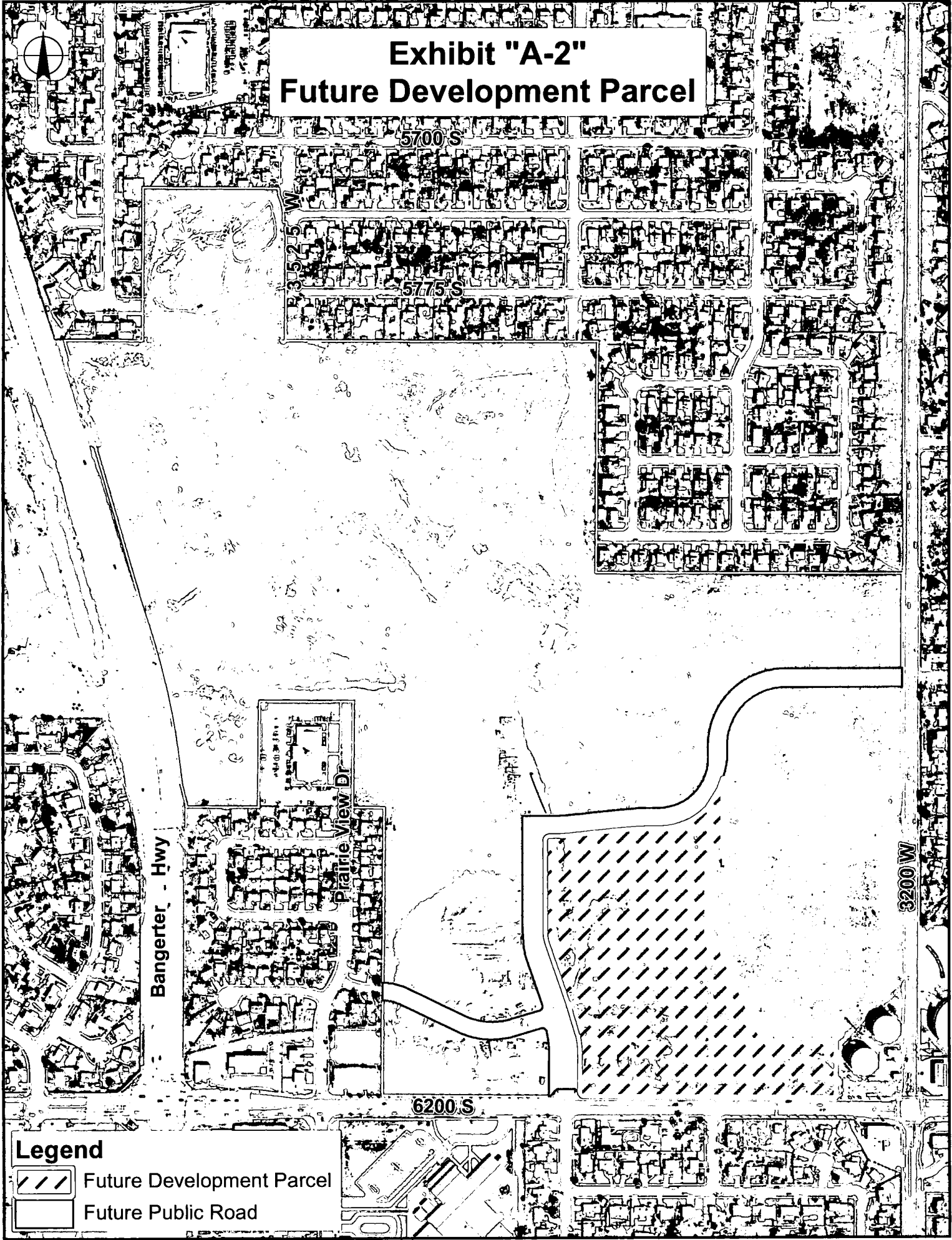

Legend



-  Future Development Parcel
-  Future Public Road

EXHIBIT "A-2"
FUTURE DEVELOPMENT PARCEL LEGAL DESCRIPTION

A tract of land, situate in the Southeast Quarter of Section 17, Township 2 South, Range 1 West, Salt Lake Base and Meridian:

Beginning on the Northerly right of way line of 6200 South Street at a point 256.23 feet North 89°57'49" West along the section line and 45.97 feet North 00°02'11" East from the Southeast corner of said Section 17 and running thence two (2) courses along said Northerly right of way line as follows: (1) North 89°57'49" West 875.60 feet; and (2) North 45°15'21" West 12.15 feet; thence North 00°37'16" East 126.81 feet to a point of curvature; thence Northerly along the arc of a 561.82 foot radius curve to the left a distance of 33.47 feet (Delta Angle equals 03°24'50" and Long Chord bears North 01°05'09" West 33.47 feet) to a point of compound curvature; thence Northerly along the arc of a 200.00 foot radius curve to the left a distance of 47.13 feet (Delta Angle equals 13°30'07" and Long Chord bears North 09°32'37" West 47.02 feet); thence North 16°17'40" West 84.48 feet to a point of curvature; thence Northerly along the arc of a 551.82 foot radius curve to the left a distance of 26.36 feet (Delta Angle equals 02°44'12" and Long Chord bears North 17°39'46" West 26.35 feet); thence North 19°01'52" West 213.26 feet to a point of curvature; thence Northerly along the arc of a 157.00 foot radius curve to the right a distance of 52.15 feet (Delta Angle equals 19°01'52" and Long Chord bears North 09°30'56" West 51.91 feet); thence due North 305.55 feet to a point of curvature; thence Northeasterly along the arc of a 15.00 foot radius curve to the right a distance of 23.56 feet (Delta Angle equals 90°00'00" and Long Chord bears North 45°00'00" East 21.21 feet); thence due East 14.29 feet to a point of curvature; thence Easterly along the arc of a 435.00 foot radius curve to the left a distance of 43.36 feet (Delta Angle equals 05°42'40" and Long Chord bears North 87°08'40" East 43.34 feet); thence North 84°17'20" East 207.36 feet to a point of curvature; thence Easterly along the arc of a 765.00 foot radius curve to the right a distance of 66.24 feet (Delta Angle equals 04°57'40" and Long Chord bears North 86°46'10" East 66.22 feet); thence North 89°15'00" East 48.66 feet to a point of curvature; thence Northeasterly along the arc of a 235.00 foot radius curve to the left a distance of 181.77 feet (Delta Angle equals 44°19'05" and Long Chord bears North 67°05'27" East 177.27 feet); thence North 33°05'30" East 48.22 feet to a point of curvature; thence Northeasterly along the arc of a 230.00 foot radius curve to the left a distance of 68.98 feet (Delta Angle equals 17°11'04" and Long Chord bears North 24°29'58" East 68.72 feet); thence South 00°05'56" East 230.85 feet to the point of a non-tangent curve, of which the radius point lies South 89°54'01" West; thence Southwesterly along the arc of a 50.00 foot radius curve to the right a distance of 83.55 feet (Delta Angle equals 95°44'28" and Long Chord bears South 47°46'15" West 74.16 feet); thence South 00°06'17" East 258.58 feet to the point of a non-tangent curve, of which the radius point lies South 00°30'26" West; thence Southeasterly along the arc of a 40.00 foot radius curve to the right a distance of 45.32 feet (Delta Angle equals 64°55'10" and Long Chord bears South 57°01'59" East 42.94 feet); thence South 24°34'23" East 336.79 feet to the point of a non-tangent curve, of which the radius point lies North 65°26'22" East; thence Southeasterly along the arc of a 20.00 foot radius curve to the left a distance of 22.83 feet (Delta Angle equals 65°24'11" and Long Chord bears South 57°15'43" East 21.61 feet); thence South 89°57'49" East 249.10 feet to the West Boundary line of the Jordan Valley Water Conservancy District Property; thence due South 212.61 feet along said West Boundary line to the Point of Beginning.

Containing 14.025 acres, more or less.

Exhibit "B" Retirement Community Concept Plan

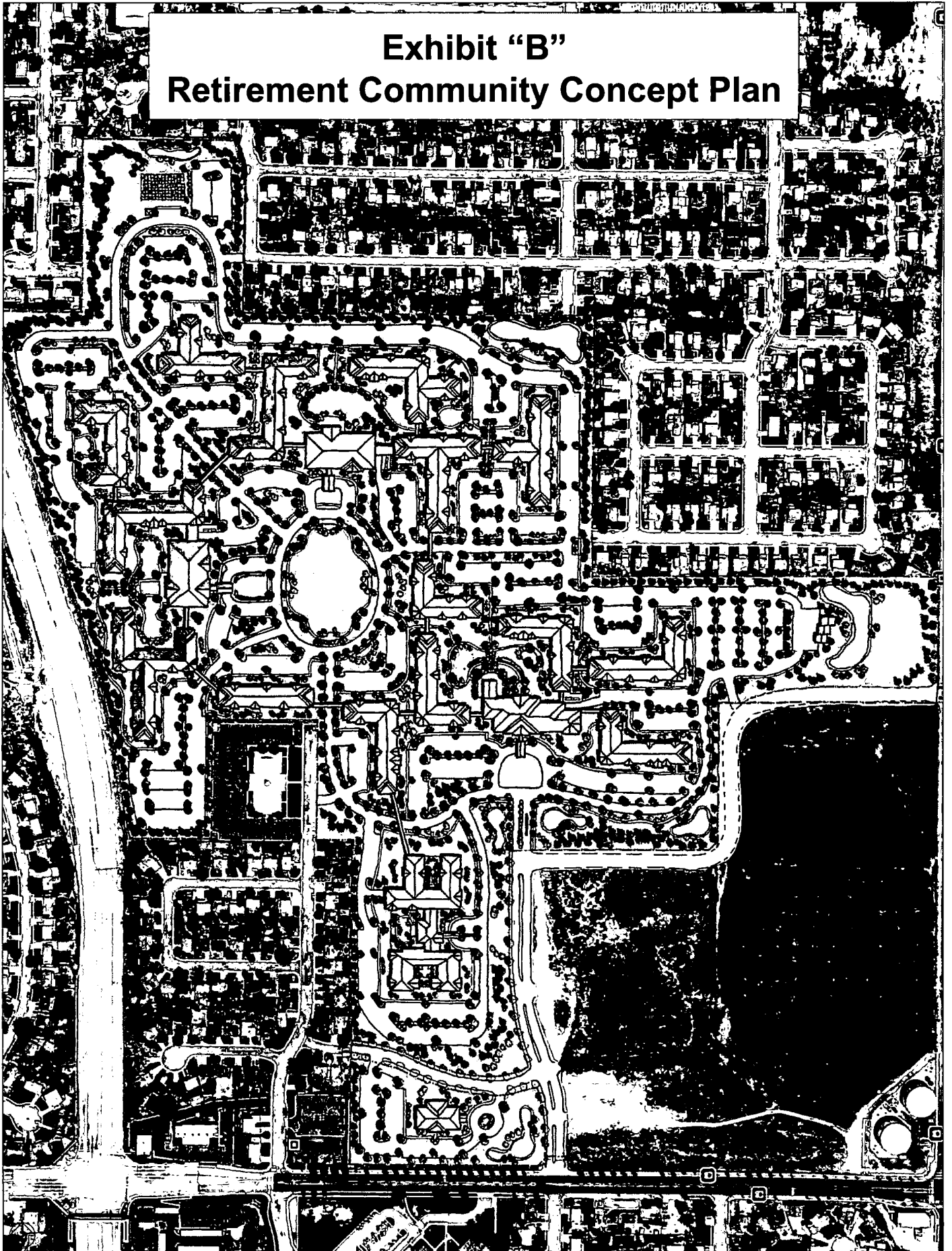

Exhibit "B"

Retirement Community Concept Plan (cont'd)

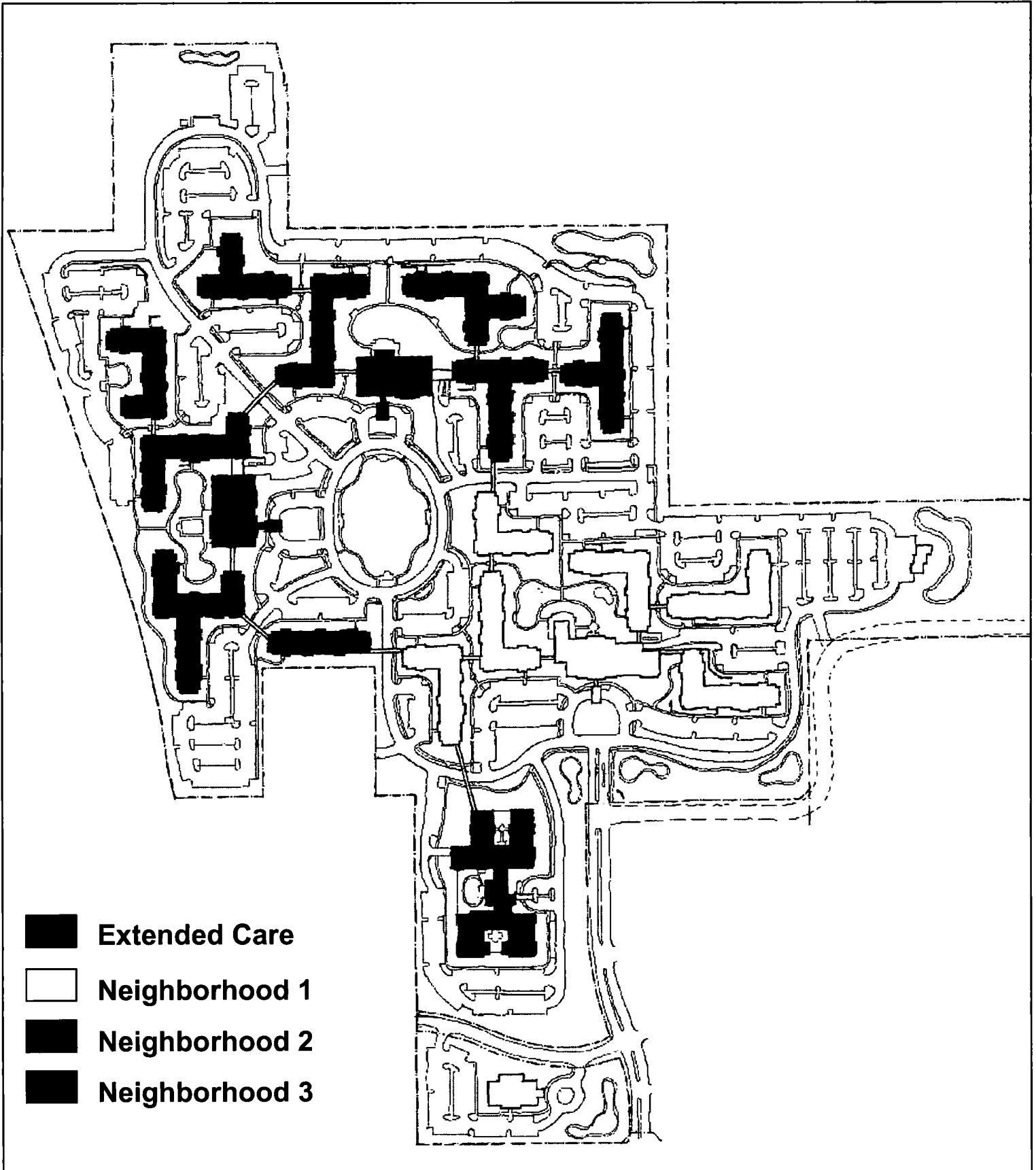
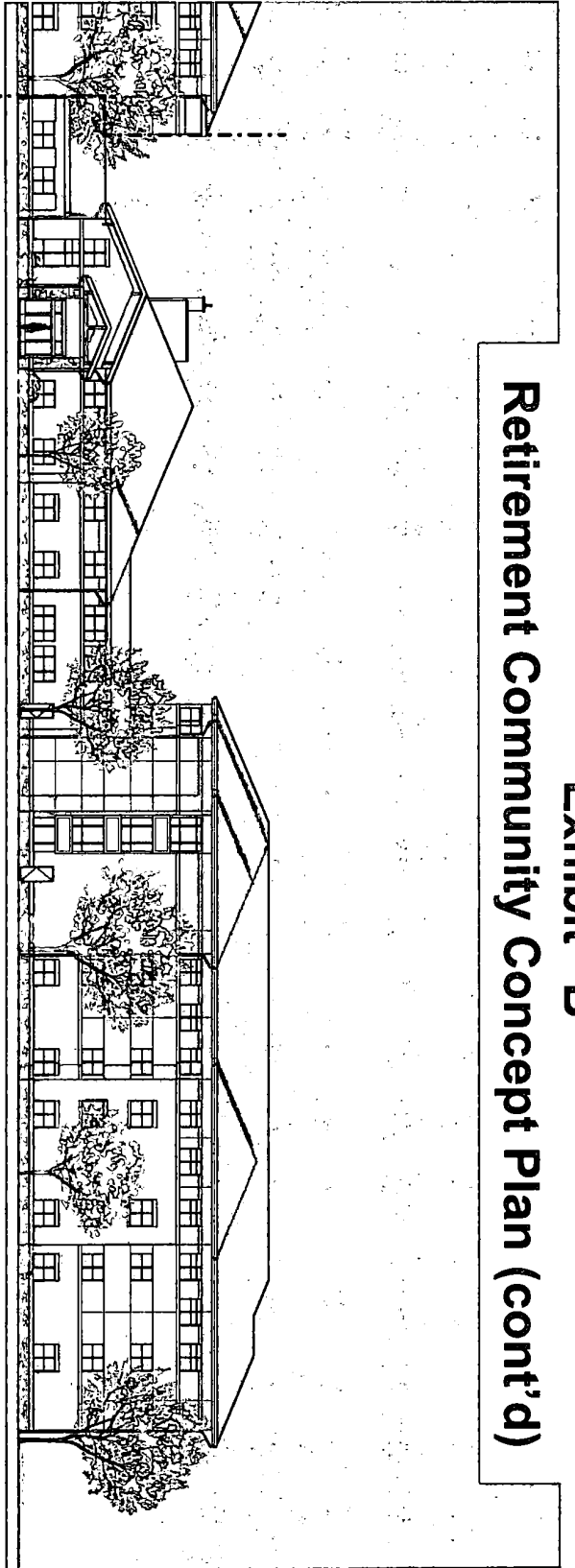
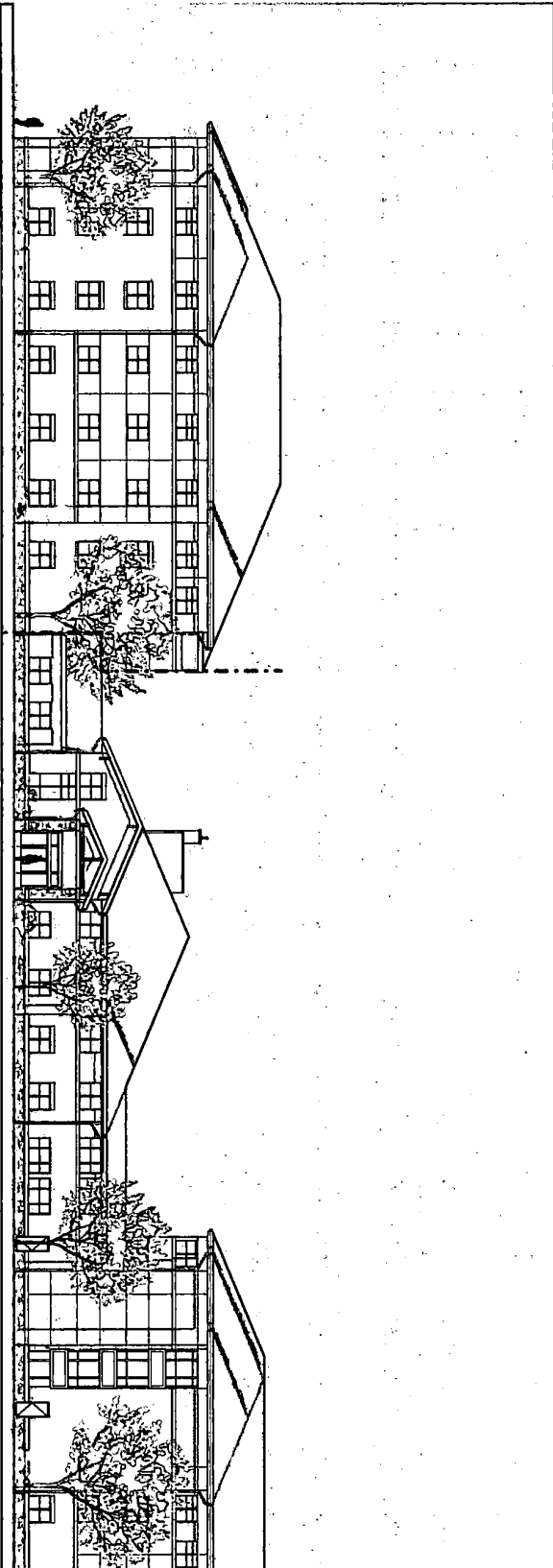

Exhibit "B"

Retirement Community Concept Plan (cont'd)



① EXTENDED CARE TYPICAL ELEVATION PHASE 1



② EXTENDED CARE TYPICAL ELEVATION PHASE 2



KHRW & Associates LLC
an equal opportunity employer • Consulting, Architecture, Planning & Management Services
 3328 Greenway Drive Ellicott City MD 21042 / 410.277.4281



GREAT BASIN ENGINEERING, INC.
INCORPORATED IN THE STATE OF UTAH • 1000 SOUTH 1000 WEST, SUITE 200, TAYLORSVILLE, UTAH 84123
 WWW.GREATBASINENGINEERING.COM

ERICKSON ENTERPRISES INC.
MANAGED CARE COMMUNITY DEVELOPMENT

PROPOSED CONTINUING CARE RETIREMENT COMMUNITY
 3360 WEST 6200 SOUTH STREET AND 6074 SOUTH 3200 WEST STREET
 TAYLORSVILLE, UTAH 84123

NO.	DATE	DESCRIPTION

TYPICAL ECC ELEVATIONS

A-4

Exhibit "B"

Retirement Community Concept Plan (cont'd)

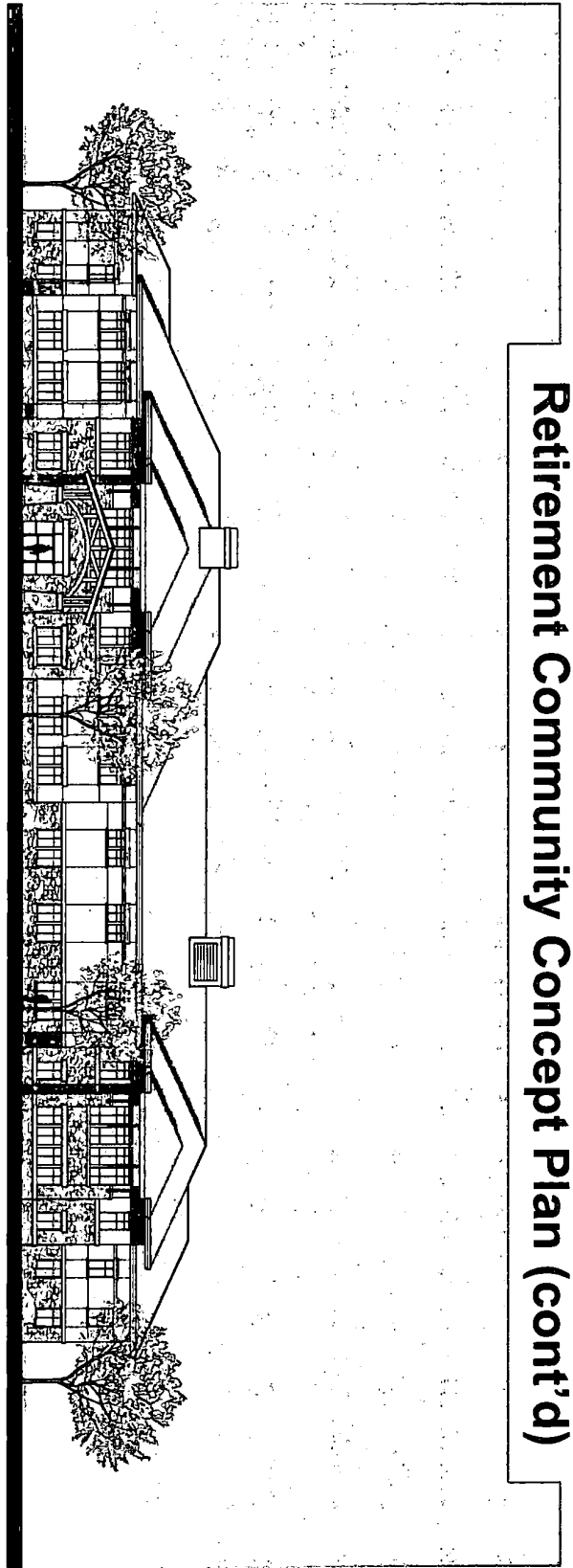

① NEIGHBORHOOD 1 COMMUNITY BUILDING TYPICAL ELEVATION

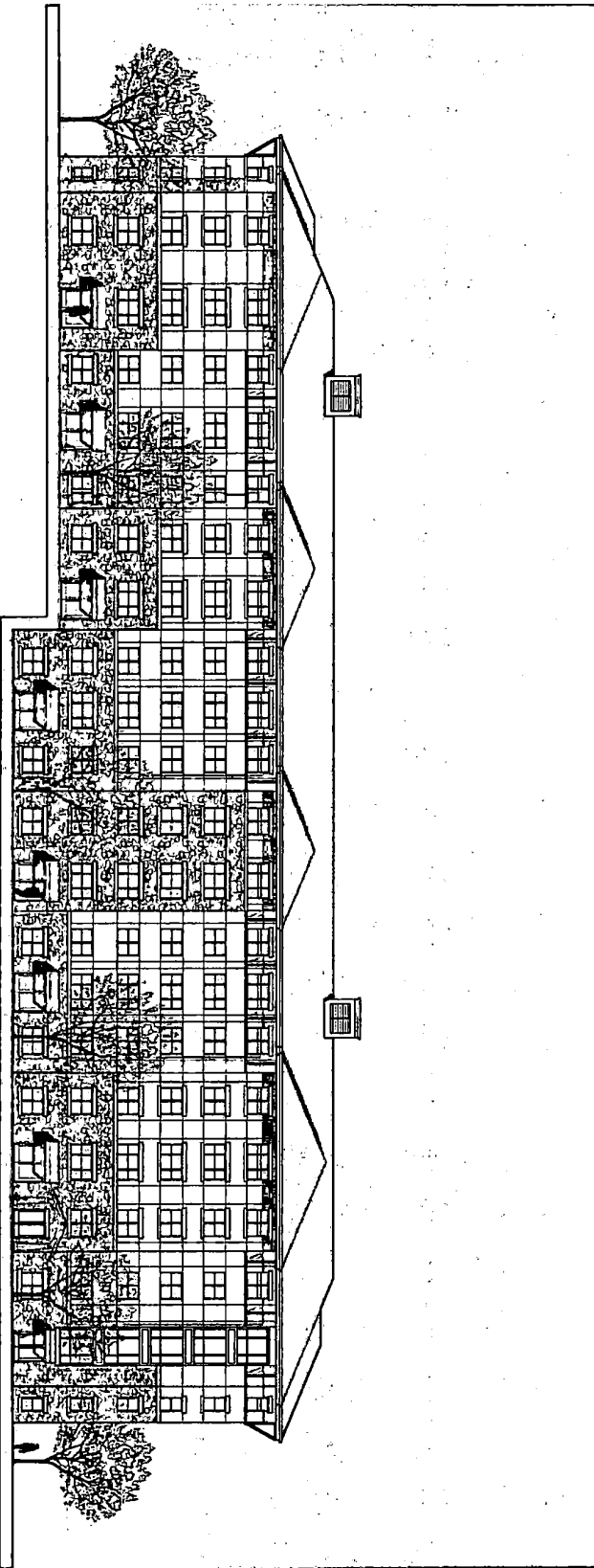

② NEIGHBORHOOD 1 RESIDENTIAL BUILDING TYPICAL ELEVATION



KGRW & Associates LLC
3328 Gateway Drive, Suite 200, Ogden, UT 84403
 801.224.4444



GREAT BASIN ENGINEERING INC.
3000 West 1200 South, Suite 200, Ogden, UT 84403
 801.224.4444

ERICKSON ENTERPRISES INC.
1000 West 1200 South, Suite 200, Ogden, UT 84403
 801.224.4444

PROPOSED CONTINUING CARE RETIREMENT COMMUNITY
 3360 WEST 6200 SOUTH STREET AND 6074 SOUTH 3200 WEST STREET
 TAYLORSVILLE, UTAH 84123

NO.	DATE	DESCRIPTION	BY

TYPICAL ELEVATIONS
 NB1
A-1

Exhibit "B"

Retirement Community Concept Plan (cont'd)

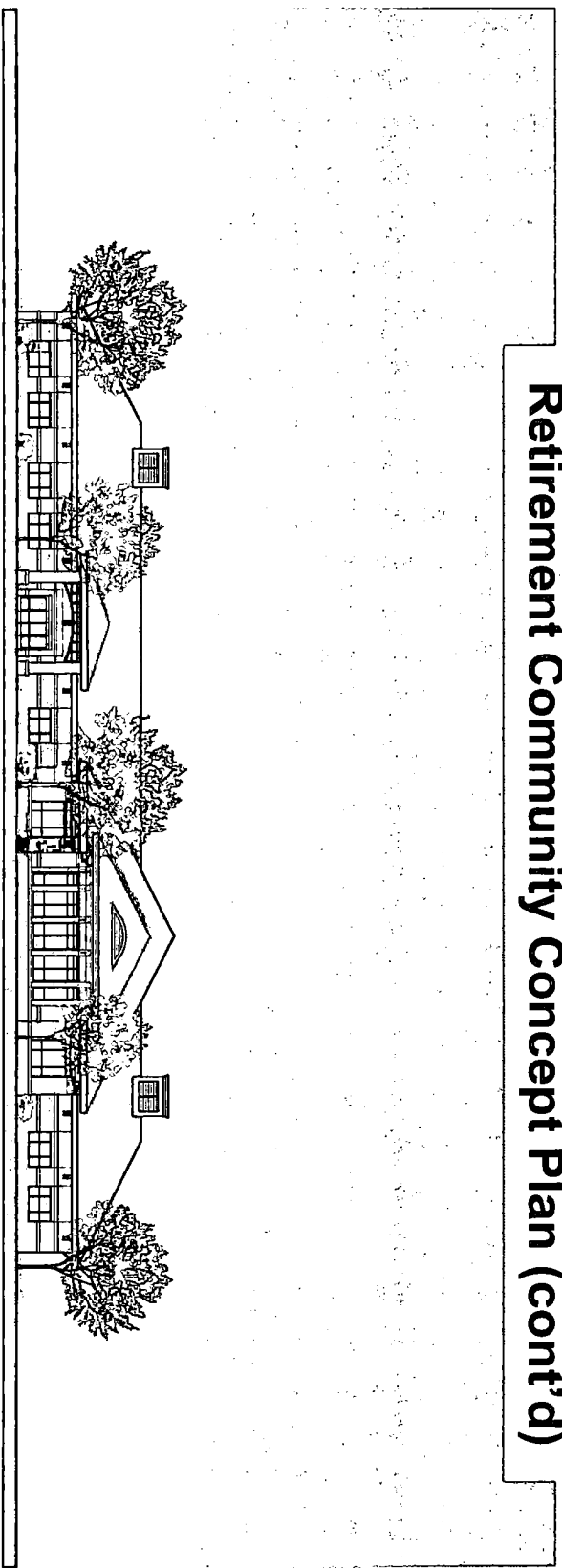

① NEIGHBORHOOD 2 COMMUNITY BUILDING TYPICAL ELEVATION

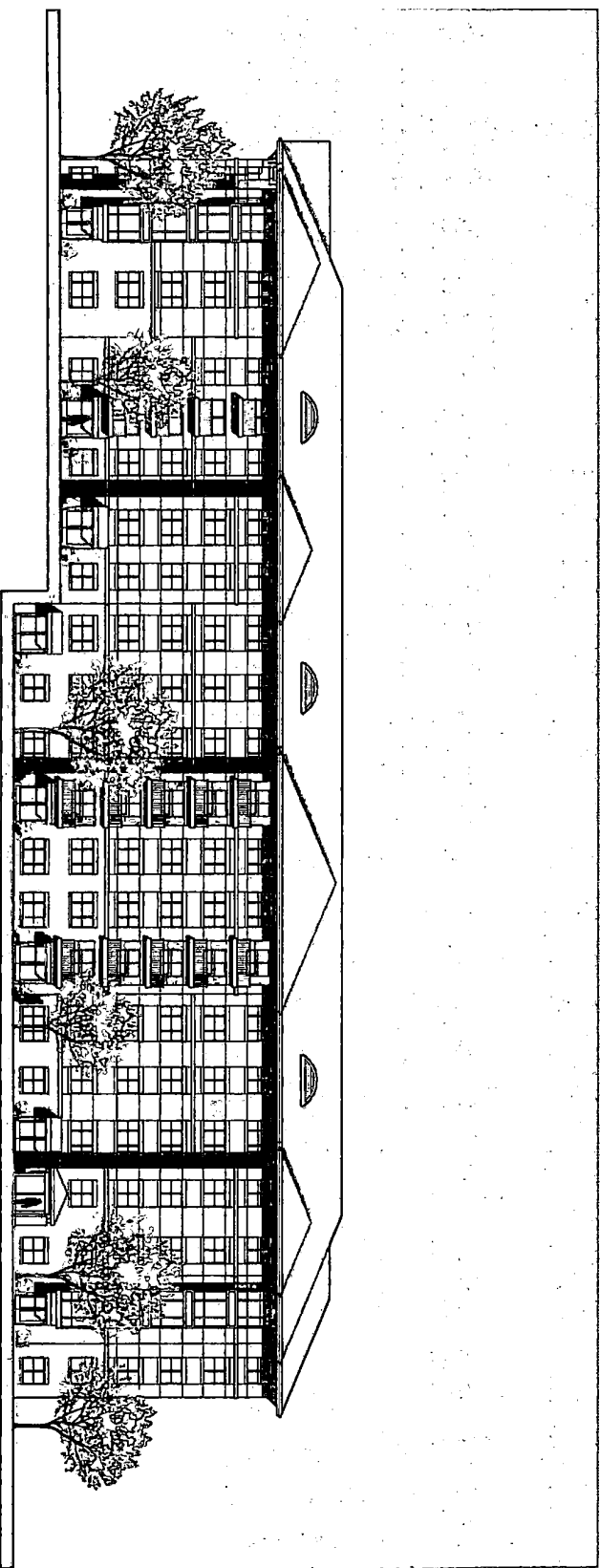

② NEIGHBORHOOD 2 RESIDENTIAL BUILDING TYPICAL ELEVATION



ERICKSON ENTERPRISES INC.
2025 RICHMOND BLVD. SUITE 100
 TAYLORSVILLE, UT 84123

PROPOSED CONTINUING CARE RETIREMENT COMMUNITY
 3360 WEST 6200 SOUTH STREET AND 6074 SOUTH 3200 WEST STREET
 TAYLORSVILLE, UTAH 84123

TYPICAL NB2 ELEVATIONS
A-2

Exhibit "B"

Retirement Community Concept Plan (cont'd)



① NEIGHBORHOOD 3 COMMUNITY BUILDING TYPICAL ELEVATION

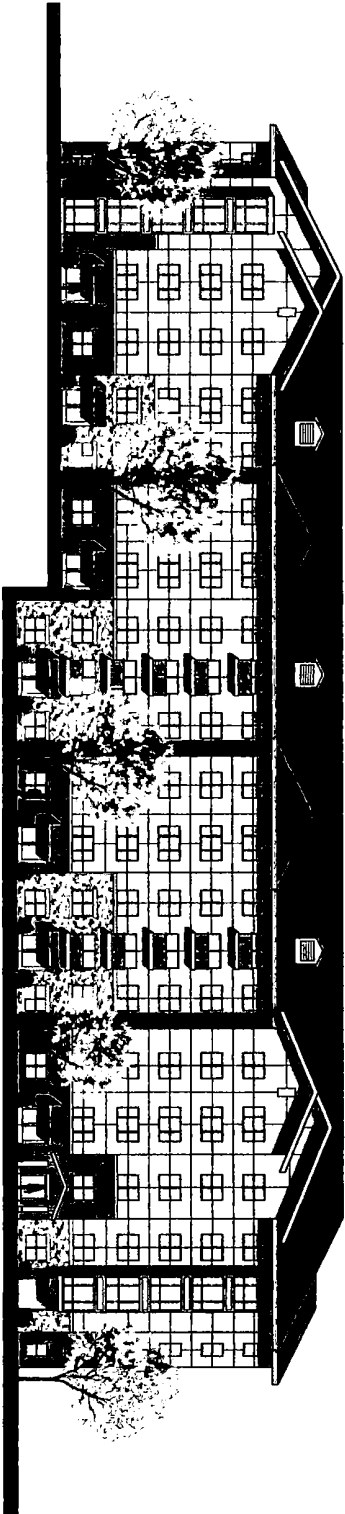

② NEIGHBORHOOD 3 RESIDENTIAL BUILDING TYPICAL ELEVATION

KGW ASSOCIATES LLC.
 2200 Channing Drive, Suite 200, Provo, UT 84601
 801.734.7900 / 801.734.7901

G B ENGINEERING
 100 SOUTH 100 WEST, SUITE 200, PROVO, UT 84601
 801.734.7900 / 801.734.7901

ERICKSON ENTERPRISES INC.
 100 SOUTH 100 WEST, SUITE 200, PROVO, UT 84601
 801.734.7900 / 801.734.7901

PROPOSED CONTINUING CARE RETIREMENT COMMUNITY
 3360 WEST 6200 SOUTH STREET AND 6074 SOUTH 3200 WEST STREET
 TAYLORSVILLE, UTAH 84123

NBS TYPICAL ELEVATIONS
 A-3

EXHIBIT C:
SSD-X-BENNION POINT Zoning District

- 1
- 2
- 3
- 4 **13.38.1: Purpose**
- 5 **13.38.2: Applicability**
- 6 A. Boundary Descriptions
- 7 B. Conflicts
- 8 C. Desirable Elements of Project Design:
- 9 D. Unacceptable Elements of Project Design:
- 10 **13.38.3: Land Use and Density**
- 11 A. Matrix Explanation
- 12 B. Table of Uses
- 13 C. Density
- 14 **13.38.4: Architectural Design**
- 15 A. Purpose and Intent:
- 16 B. Building Relationships and Compatibility:
- 17 C. Building Heights:
- 18 D. Building Massing, Forms, and Pedestrian Scale:
- 19 E. Roof Forms and Materials:
- 20 F. Roof-mounted Equipment:
- 21 G. Building Materials:
- 22 H. Building Colors:
- 23 I. Building Entrances:
- 24 J. Energy Conservation Measures
- 25 **13.38.5: Site Planning**
- 26 A. Purpose and Intent:
- 27 B. Building Siting and Orientation
- 28 C. Building and Parking Setbacks:
- 29 D. Lot Regulations:
- 30 E. Site Coverage Requirements:
- 31 F. Landscape Design
- 32 G. Utilities and Mechanical Equipment:
- 33 H. Service, Refuse, Delivery, and Storage Areas:
- 34 **13.38.6: Grading and Drainage**
- 35 A. Water Quality Control + Drainage:
- 36 B. Site Grading and Excavation:
- 37 **13.38.7: Vehicular Circulation and Parking**
- 38 A. Purpose and Intent:
- 39 B. Vehicular Access:
- 40 C. Vehicular Circulation:
- 41 D. Service/Delivery and Emergency Access:
- 42 E. Surface Parking Lots:
- 43 F. Parking Structures and Parking Beneath Buildings:
- 44 G. Future Parking Lots and Structures
- 45 H. Mass Transit Facilities:
- 46 **13.38.8: Pedestrian Mobility, Bicycle Circulation and Parking**
- 47 A. Purpose and Intent:
- 48 B. Overall Pedestrian and Bicycle Circulation:
- 49 C. Bicycle Circulation and Parking:
- 50 **13.38.9: Screen Walls and Fences**
- 51 A. Purpose and Intent
- 52 B. Wall and Fence Design and Materials
- 53 C. Screening Requirements
- 54 **13.38.10: Sign Design**

55 **13.38.11: Exterior Site Lighting**

- 56 A. Purpose and Intent
- 57 B. Fixture Design and Illumination Level
- 58 C. Decorative Architectural Lighting
- 59 D. Parking Lot Lighting
- 60 E. Pedestrian Area Lighting
- 61 F. Landscape Lighting
- 62 G. Site Security Lighting
- 63 H. Light Intensity

64
65 **13.38.1: Purpose**

66 The Site Specific Development Mixed Use Bennion Point (SSD-X-BENNION POINT) District is established to
67 promote the public health, safety and welfare of the community by facilitating the creation of an integrated
68 senior community in a campus setting of sufficient size to provide a variety of housing types serving seniors,
69 including independent living units and residential units for seniors requiring a range of health care services,
70 as well as health care support and appropriate ancillary and accessory uses. It is the purpose of this section to
71 encourage flexibility of design and development of land in a manner that suits the unique needs of a
72 retirement community but will also contribute to orderly traffic circulation and compatibility with
73 surrounding land uses. All new or future development within the SSD-X-BENNION POINT zoning district shall
74 be in conformity with a site-specific Master Plan approved by the Planning Commission. Specifically, this zone
75 intends to:

- 76
77 A. Enhance and protect the quality of life and community image of the City of Taylorsville through
78 clearly articulated development design policies and minimum design standards;
- 79
80 B. Protect and promote Taylorsville’s long-term economic vitality through design standards which
81 encourage and reward high quality development and discourage less attractive and less enduring
82 alternatives;
- 83
84 C. Minimize adverse impacts of vehicular circulation to existing neighborhoods and to the surrounding
85 physical environment;
- 86
87 D. Enhance and protect the security, health, safety, and welfare of all residents of the City of
88 Taylorsville; and
- 89
90 E. Facilitate an understanding of the City’s expectations and notify and assist developers in compiling a
91 complete and efficient application.

92
93 **13.38.2: Applicability**

94 The provisions in this chapter shall apply to all new development, redevelopment, exterior remodels,
95 additions to existing structures, refacing, and accessory structures within the SSD-X-BENNION POINT zoning
96 district. This chapter includes minimum development standards and will be used by City staff and the
97 Planning Commission to review development applications. The policies established in these provisions shall
98 be met through actual compliance with each design standard.

- 99
100 A. Boundary Descriptions: The SSD-X-BENNION POINT zoning district is limited to a specific area in the
101 City as illustrated in Figure 1, which is described as:

102
103 A tract of land, situate in the Southeast Quarter of Section 17, Township 2 South, Range 1 West, Salt Lake Base
104 and Meridian:

105
106 Beginning on the Northerly right of way line of 6200 South Street at a point 59.83 feet North 89°57'49" West
107 along the section line and 45.96 feet North 00°02'11" East from the Southeast corner of said Section 17 and
108 running thence along said Northerly right of way line the following nine (9) courses (1) North 89°57'49" West
109 140.40 feet; (2) South 29°27'10" East 14.89 feet; (3) North 89°57'56" West 70.17 feet; (4) North 29°27'10"

110 West 14.89 feet (5) North 89°57'49" West 861.44 feet; (6) North 45°15'21" West 35.14 feet; (7) South
111 89°44'39" West 63.00 feet; (8) South 44°44'39" West 34.33 feet and (9) North 89°57'49" West 578.90 feet to
112 the East Boundary line of Prairie View Condominiums, a condominium development in Taylorsville City, Salt
113 Lake County Utah; thence North 00°16'50" East 987.04 feet along said East Boundary line and the East
114 Boundary line of Stonewood Subdivision, a residential development in Taylorsville City, Salt Lake County
115 Utah, to the Northeast corner of said subdivision; thence North 89°57'49" West 110.00 feet along the North
116 Boundary line of said subdivision to the East right of way line of 3500 West Street; thence North 00°16'50"
117 East 363.00 feet; thence North 89°57'49" West 321.00 feet; thence South 00°16'50" West 363.00 feet to said
118 North Boundary line; thence North 89°57'49" West 247.33 feet along said North Boundary line to the East
119 right of way line of Bangerter Highway; thence three (3) courses along said East right of way line as follows:
120 (1) North 14°07'22" West 84.43 feet to the point of curve of a non-tangent curve whose center point bears
121 South 84°03'56" West; (2) Northerly along the arc of a 2,600.67 foot radius curve to the left a distance of
122 553.16 feet (Central Angle equals 12°11'12", and Long Chord bears North 12°01'40" West 552.12 feet) ; and
123 (3) North 18°07'16" West 1,040.81 feet to the South Boundary line of Wildwood Estates No. 2, a residential
124 development in Taylorsville City, Salt Lake County Utah; thence North 89°56'25" East 297.76 feet along said
125 South Boundary line to the Southeast corner of said subdivision; thence North 00°06'28" West 527.77 feet
126 along the East Boundary line of said Whitewood Estates No. 2, to the South line of Willow Bay No. 4, a
127 residential development in Taylorsville City, Salt Lake County Utah; thence North 89°57'17" East 467.91 feet
128 along said South Boundary line to the point of curve of a non-tangent curve whose center point bears North
129 89°56'53" East; thence Southerly along the arc a 110.00 foot radius curve to the left a distance of 41.09 feet
130 (Central Angle equals 21°24'06", and Long Chord bears South 10°45'10" East 40.85 feet) to the point of curve
131 of a non-tangent curve whose center point bears South 68°32'45" West; thence Southerly along the arc a
132 140.84 foot radius curve to the right a distance of 52.74 feet (Central Angle equals 21°27'13", and Long Chord
133 bears South 10°43'39" East 52.43 feet) ; thence due South 25.50 feet; thence due East 10.00 feet to the West
134 Boundary line of Willow Bay No. 5, a residential development in Taylorsville City, Salt Lake County Utah;
135 thence due South 409.75 feet along said West Boundary line to the Southwest corner of said Willow Bay No.
136 5; thence North 89°57'26" East 1,073.01 feet along the South Boundary line of said Willow Bay No. 5, and the
137 South Boundary line of Willow Bay No. 6, a residential development in Taylorsville City, Salt Lake County
138 Utah to the West Boundary line of Willow Bay No. 7, a residential development in Taylorsville City, Salt Lake
139 County Utah; thence due South 800.00 feet along said West Boundary line to the Southeast corner of said
140 Willow Bay No. 7; thence North 89°57'26" East 1,054.11 feet along the South Boundary line of said Willow
141 Bay No. 7, and the South Boundary line of Willow Bay No. 9, a residential development in Taylorsville City,
142 Salt Lake County Utah to the West right of way line of 3200 West Street; thence South 00°06'34" East 390.85
143 feet along said West right of way line; thence South 89°53'26" West 396.32 feet to a point of curvature;
144 thence Southwesterly along the arc of a 205.00 foot radius curve to the left a distance of 321.62 feet (Delta
145 Angle equals 89°53'26" and Long Chord bears South 44°56'43" West 289.64 feet); thence due South 48.62
146 feet to a point of curvature; thence Southerly along the arc of a 230.00 foot radius curve to the right a distance
147 of 63.86 feet (Delta Angle equals 15°54'26" and Long Chord bears South 07°57'13" West 63.65 feet); thence
148 South 00°05'56" East 230.85 feet to the point of a non-tangent curve, of which the radius point lies South
149 89°54'01" West; thence Southwesterly along the arc of a 50.00 foot radius curve to the right a distance of
150 83.55 feet (Delta Angle equals 95°44'28" and Long Chord bears South 47°46'15" West 74.16 feet); thence
151 South 00°06'17" East 258.58 feet to the point of a non-tangent curve, of which the radius point lies South
152 00°30'26" West; thence Southeasterly along the arc of a 40.00 foot radius curve to the right a distance of
153 45.32 feet (Delta Angle equals 64°55'10" and Long Chord bears South 57°01'59" East 42.94 feet); thence
154 South 24°34'23" East 336.79 feet to a point of curvature; thence Southeasterly along the arc of a 20.00 foot
155 radius curve to the left a distance of 22.83 feet (Delta Angle equals 65°23'26" and Long Chord bears South
156 57°16'06" East 21.61 feet); thence South 89°57'49" East 249.10 feet to the West line Extended of the Jordan
157 Valley Water Conservancy property; thence due South 213.61 feet along said West line Extended and the
158 West line of said Property to the South line of said Property; thence South 89°57'49" East 56.00 feet along
159 said South line the Northerly right of way line of 6200 South Street; thence South 29°27'10" East 14.89 feet
160 along said Northerly right of way line to the Point of Beginning.

161 Containing 105.5681 acres, more or less.

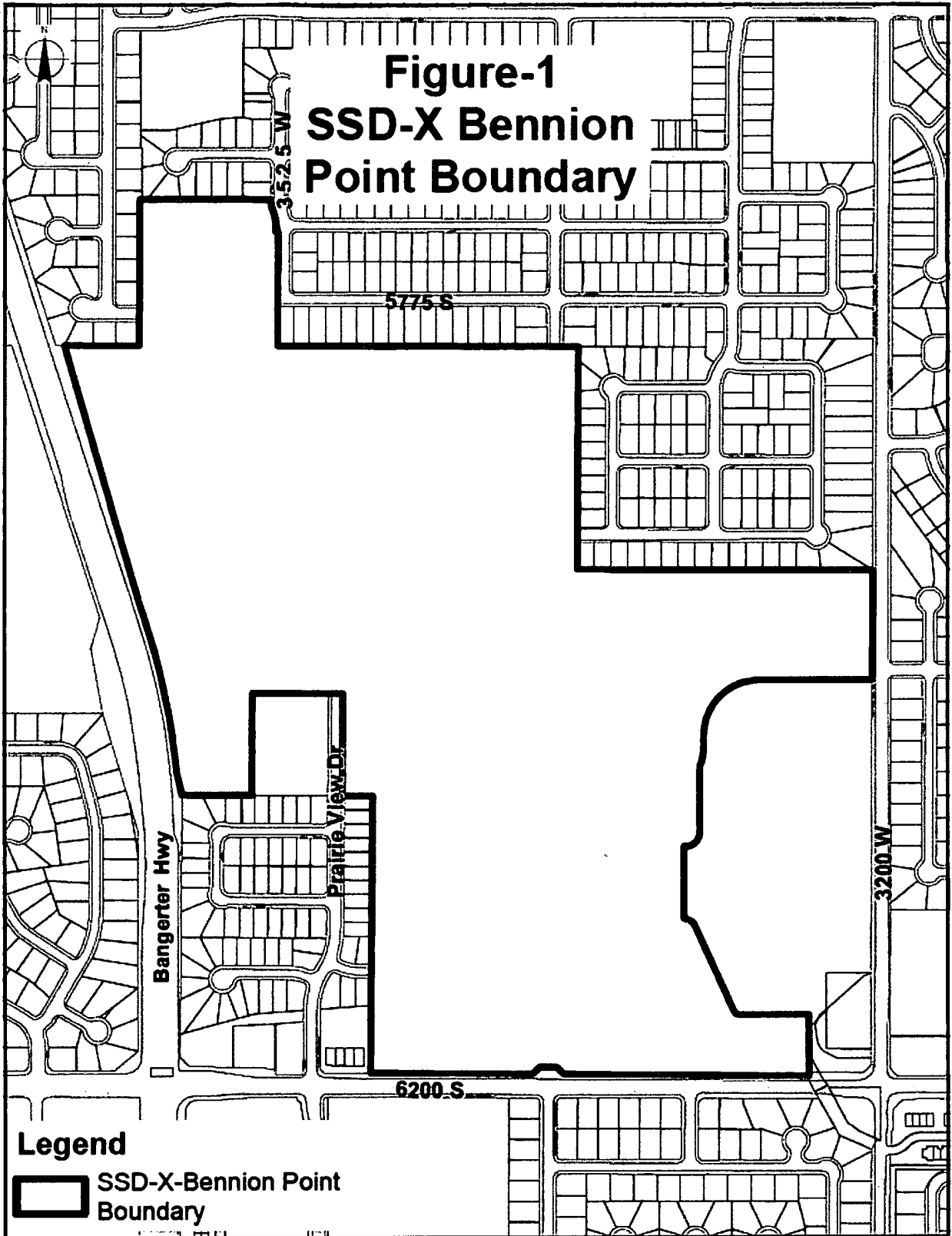

163 There exists two (2) sub districts within the SSD-X-BENNION POINT zoning district which are
164 referred to in this Ordinance as "Retirement Community Property and "Future Development Parcel":

165 1. Retirement Community Property is hereby defined as illustrated in Figure 2:

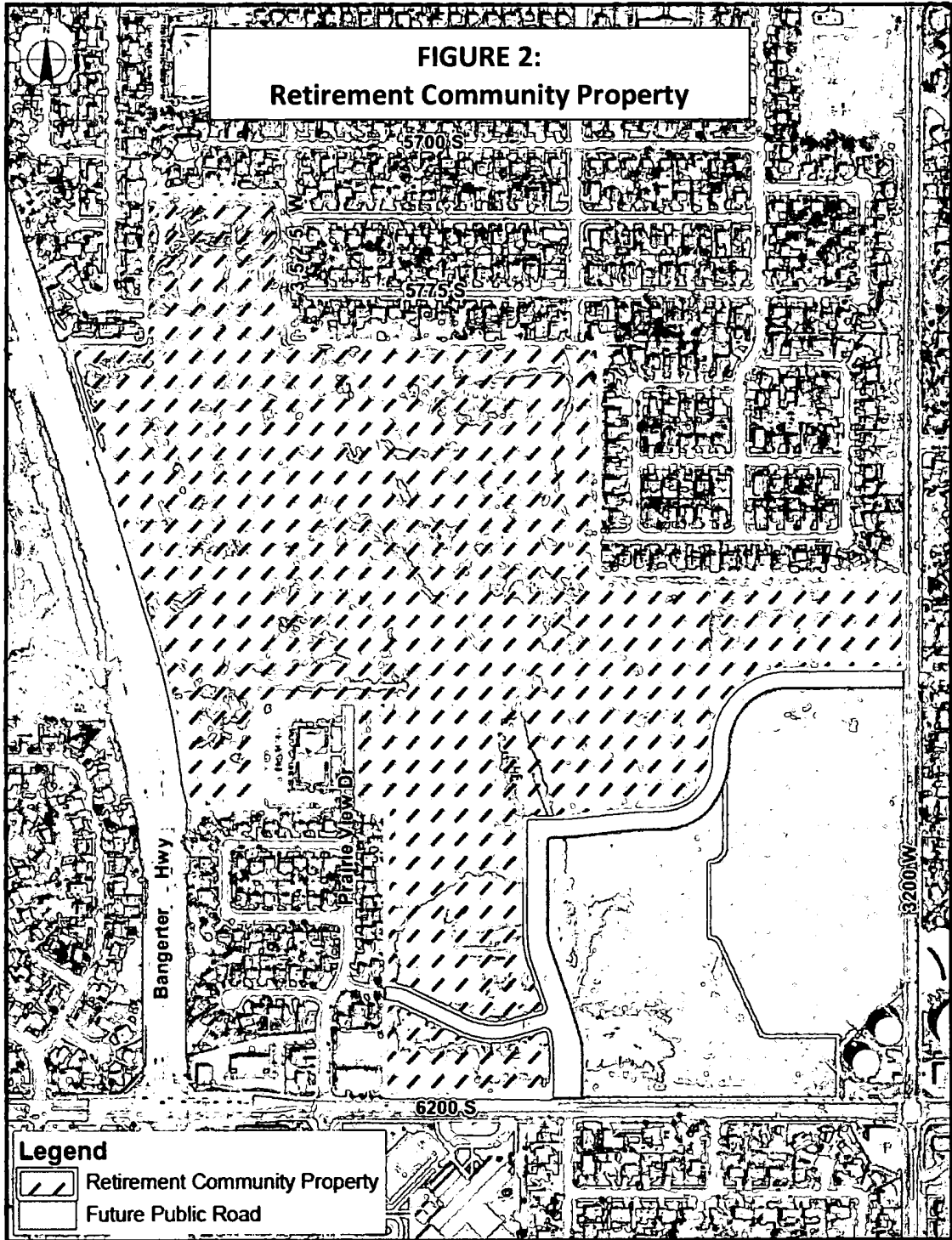

166 2. Future Development Parcel is hereby defined as illustrated in Figure 3:

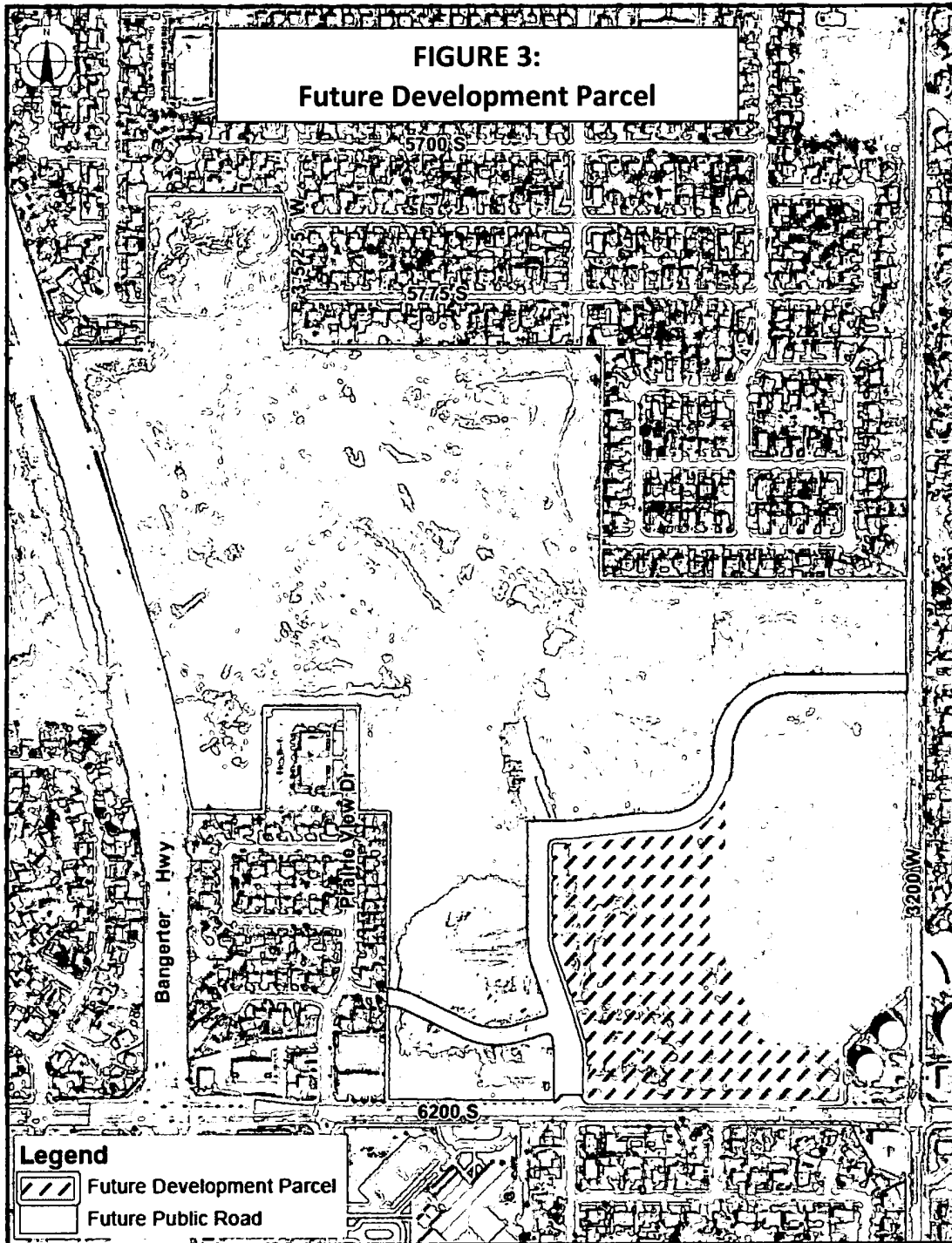

167

168

169

170

- B. Conflicts: Where a provision in this chapter is in conflict with any other provision of the City Code, the most restrictive requirement shall take precedence and shall apply. Building and life safety codes take precedence over the standards in this chapter in cases where the requirements of this chapter

171 require action in direct conflict with those codes. Any development within the SSD-X-BENNION
172 POINT zoning district shall meet the requirements of the Americans with Disabilities Act (ADA).

173
174 C. Desirable Elements of Project Design: The City considers the following design features to be desirable
175 elements of development within the SSD-X-BENNION POINT zoning district. The standards set forth
176 in this section intend to facilitate the incorporation of the following features into development
177 projects:

- 178 1. Harmonious arrangement of buildings, site landscaping, open space, development amenities,
179 parking, and access driveways with clear visibility of entrances;
- 180 2. Quality exterior building materials, colors, surfaces, textures, lighting, and architectural
181 landscape forms;
- 182 3. Architectural design treatments, including articulated building footprints to reduce massing and
183 to promote architectural definition and interest;
- 184 4. Efficient vehicular, pedestrian and bicycle circulation by way of pedestrian friendly design of
185 interior drives, parking areas, pathways, and sidewalks;
- 186 5. Landscaped and screened parking, storage, loading, and service areas;
- 187 6. Significant landscape, streetscape and hardscape elements;
- 188 7. Structures placed to create opportunities for plazas, courtyards, or gardens/patio areas which
189 can be utilized as pedestrian gathering places and common employee gathering areas with
190 appropriate site furniture and lighting;
- 191 8. Enhanced view corridors to open areas and mountain vistas;
- 192 9. Site design and site improvements which anticipate the potential re-use of the building(s) for
193 other purposes; and
- 194 10. Site and building design which complements the public realm.

195
196 D. Unacceptable Elements of Project Design: The City considers the following design features to be
197 unacceptable elements of development including:

- 198 1. Poorly defined site access points;
- 199 2. Disjointed parking areas, or confusing or unsafe circulation patterns;
- 200 3. Square, 'box-like' structures with large, blank, unarticulated wall surfaces;
- 201 4. Highly reflective surfaces or repetitious and continuous glazing patterns;
- 202 5. Metal siding used as a primary exterior façade treatment;
- 203 6. Visible outdoor storage, loading, and equipment areas;
- 204 7. Signage which is redundant or out of scale with building architecture; and
- 205 8. Site and building design which "turns its back" to the public realm.

206
207
208
209
210
211
212
213
214
215
216
217
218
219
220
221
222
223
224
225 **13.38.3: Land Use and Density**

226 A. Matrix Explanation: Uses permitted under this chapter shall conform to the development standards
 227 provided elsewhere in this development code, the application procedures for development, and any
 228 overlay districts as applicable. Uses permitted as a conditional use shall comply with the
 229 requirements for administrative conditional use permits and/or non-administrative conditional use
 230 permits as applicable.

231
 232 The land use matrix is divided into two (2) sub districts, "Retirement Community Property" and
 233 "Future Development Parcel". A concept plan for the Future Development Parcel may propose an
 234 expansion of the uses and concept plan approved for the Retirement Community Property, but
 235 pursuant to the provisions of Section 13.19.010(C) and (E) of this Code. The approval of any
 236 additional land uses beyond those allowed as part of the Retirement Community Property as set forth
 237 in the table below, a concept plan including any additional commercial uses and site specific
 238 development standards for such uses on the Future Development Parcel shall require and be
 239 contingent upon the favorable exercise of future legislative discretion by the City Council following
 240 all required notice and public hearings before the Planning Commission and City Council. Please refer
 241 to 13.38.2A for definitions of these sub districts.

- 242
 243 P = Permitted
 244 AC = Administrative conditional
 245 NC = Nonadministrative conditional
 246 S = Special use permit
 247 N = Not permitted
 248

249 B. Table of Uses:
 250

Land Use	Retirement Community Property
Accessory Structure	P
Assisted Living Unit	NC
Continuing Care Retirement Community	NC
Animals (household pets)	P
Continuing Care Retirement Community Accessory Uses	NC
Independent Apartment Unit	NC
Home Occupation	P
Skilled Nursing Care Unit	NC
Parking, Structure/terrace	AC
Parking, Underground	P
Parks, public and private	P
Senior Apartment Units	NC
Professional Office	NC
Solar Equipment	AC
Wireless telecommunications facility	NC

251
 252 C. Density: Allowable dwelling units per acre are maximums based upon suitable design and
 253 compliance with the standards in the City Code.
 254

	Minimum Allowable Units per Acre	Maximum Allowable Units per Acre
Retirement Community Property	23	30

255
256
257
258
259
260
261
262
263
264
265
266
267
268
269
270
271
272
273
274
275
276
277
278

13.38.4: Architectural Design

A. Purpose and Intent: Architectural design seeks to add to community character while providing flexibility to avoid rigid uniformity of design. All elements including the scale and mass of buildings, materials, color, roof styles, door and window openings, and details should be responsive to functional architectural design and promote a cohesive design statement. Property owners and developers are encouraged to employ best practices and innovative design so buildings can be energy efficient to conserve natural resources.

Building masses shall respond to "human scale" with materials and details that are proportionate to human height and provide visual interest at the street and sidewalk level. Buildings shall be reduced in apparent mass or articulated to avoid large monolithic, box-like shapes.

B. Building Relationships and Compatibility: Buildings or portions of buildings shall be oriented on a site to create a strong relationship to the public and private right of way and adjacent structures, providing visual continuity and compatibility. Buildings shall be located to minimize the view of parking and loading areas, outside storage areas, ground mounted mechanical equipment and trash and service enclosures from all adjoining public rights of way.

C. Building Heights: Appropriate measures shall be taken into consideration to ensure building heights are compatible with adjacent development (existing or planned). Buildings over 35 feet in height shall comply with the setback height ratios, established by measuring the ratio of the horizontal distance between any part of a building or structure and the nearest adjacent property line at grade:

Property Line Adjacent to	Height Setback Ratio (feet) horizontal : vertical
Residential Land Use (where the building face is parallel to the adjacent residential property line for a distance greater than 90 feet) (see Figure 4 and Figure 5)	2.25 : 1
Residential Land Use (where the building face is perpendicular to the adjacent residential property line for a distance less than 90 feet) (see Figure 6 and Figure 7)	1.75 : 1
Non Residential Land Use	0.5 : 1
Open Space	0.5 : 1
Bangerter Highway	0.5 : 1

279

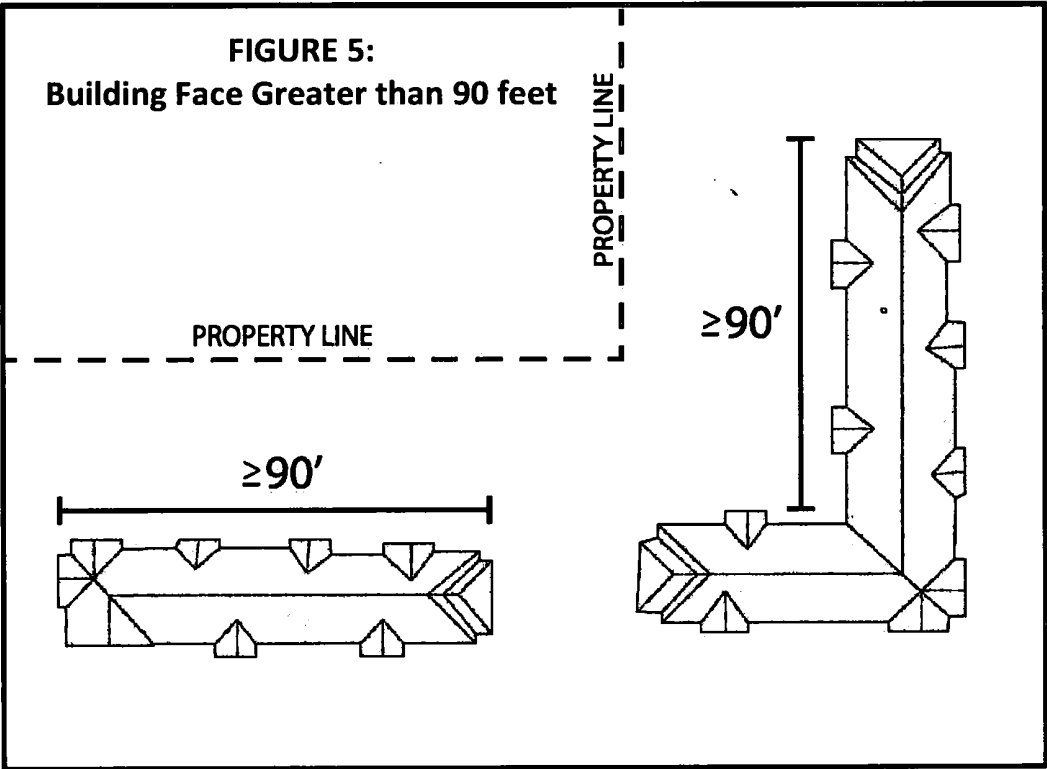
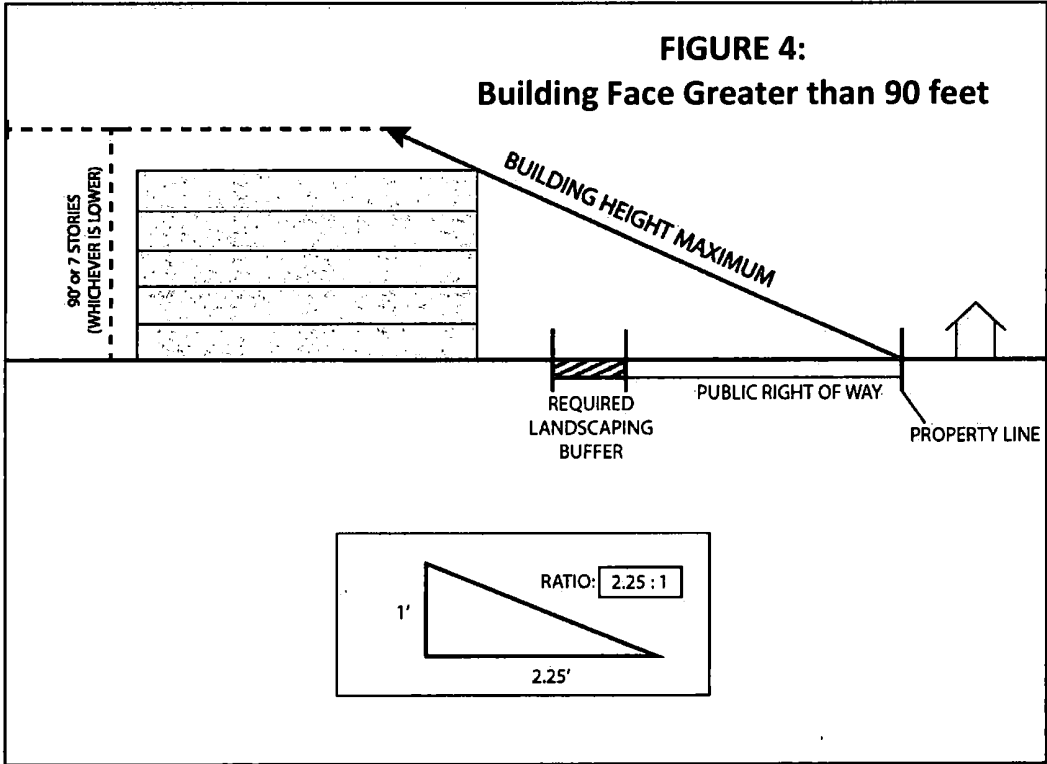

282
283
284
285
286
287
288
289
290
291
292
293
294
295
296
297
298
299
300
301
302
303
304
305
306
307
308
309

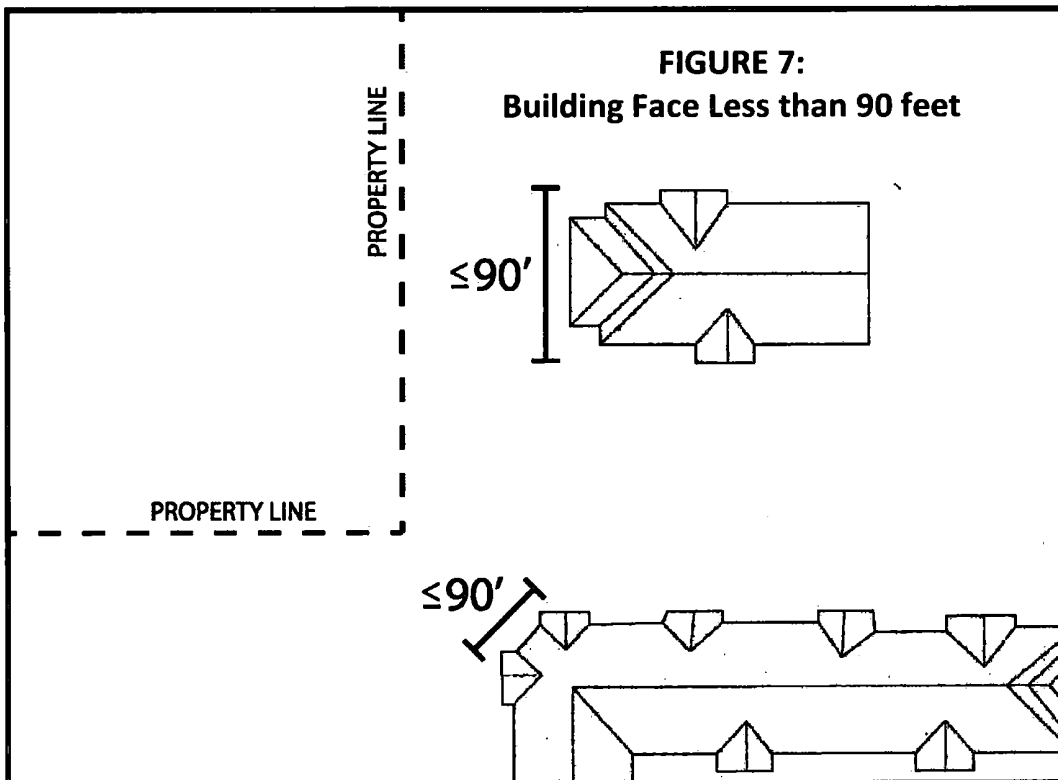
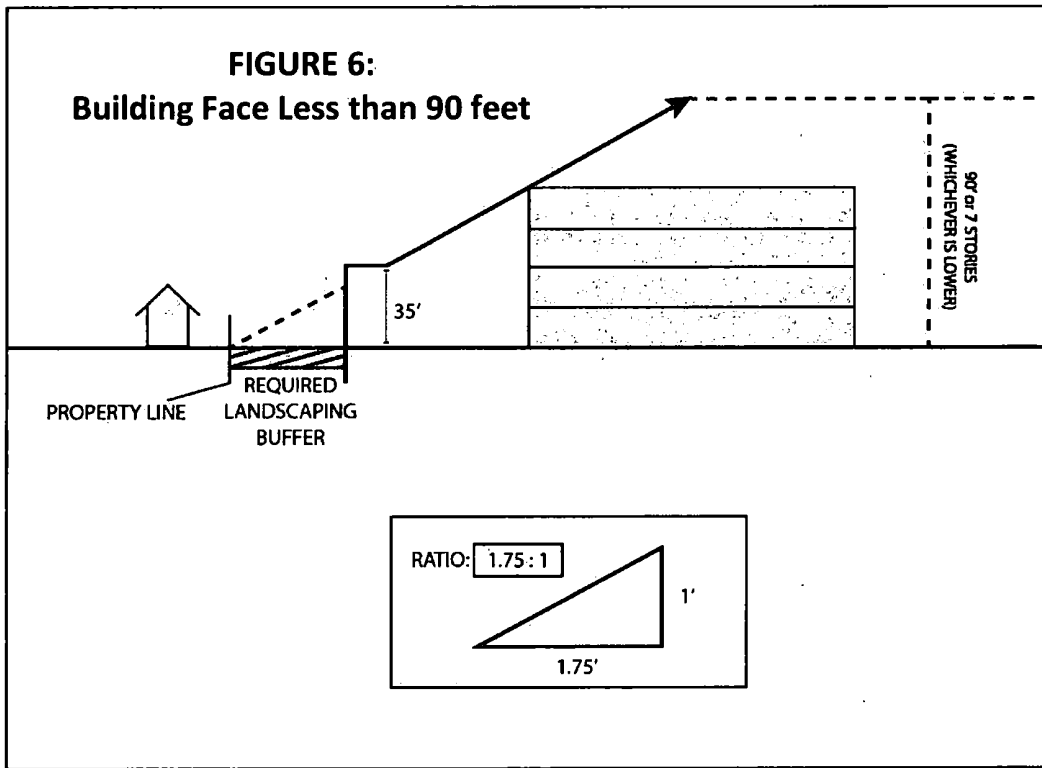

310
311
312
313
314
315
316
317
318
319
320
321
322
323
324
325
326
327
328
329
330
331
332
333
334
335
336
337
338
339
340
341
342
343
344
345
346
347
348
349
350
351
352
353
354
355
356
357
358
359
360
361
362
363
364

1. The maximum height of any structure shall not exceed 90 feet or 7 stories above mean ground elevation around the perimeter of the building, whichever is lower.
 2. Where a property line is immediately adjacent to a street or public right of way, the land use or zoning district of the property immediately across said street or right of way will govern the height setback ratio, unless otherwise stated in the above table. For these instances, horizontal distance is measured from the property line across the street. (see Figure 6)
- D. Building Massing, Forms, and Pedestrian Scale: Buildings shall relate to each other in their massing and forms. Square "boxlike" structures with large, blank, unarticulated wall surfaces are deemed to be unacceptable. Buildings adjacent to pedestrian walks and paths shall have features and patterns that provide visual interest at the scale of the pedestrian which reduces apparent mass and relates to local architectural character.
1. Exterior building walls shall incorporate architectural features and treatments to diminish the building mass. Architectural design shall anticipate the combination of the following techniques or other appropriate techniques to be reviewed and approved by the Planning Commission. Each principal building shall meet the following three (3) standards:
 - a. Horizontal Articulation: Each façade greater than 50 feet in length, measured horizontally, shall incorporate architectural features such as wall plane projections, recesses, or other building material treatments and textures that visually interrupt the wall plane. No uninterrupted length of any facade may exceed 50 horizontal feet;
 - b. Vertical Articulation: Each principal building greater than 55 feet in height shall have a change in cladding material or surface plane. No single cladding material or surface plane (as applicable) may extend for an uninterrupted vertical distance of more than 55 feet; and
 - c. Parapet Variation: All facades visible from a public street shall include a parapet that varies in height by at least 18 inches for each 50 linear feet of façade length. This requirement does not apply to buildings with sloped roofs.
- E. Roof Forms and Materials: Rooftops are deemed to contribute to the unified appearance of each development and may be observed from higher areas, ground level, other buildings and roadways.
1. Sloped roofs shall provide articulation and variations a minimum of every 75 feet in order to break up the massiveness of the roof. Sloped roofs shall include eaves which are at least 18 inches in width.
 2. All parapets shall feature cornice treatments. Parapets shall provide a cap element to demonstrate that the upper edge is the top of the building.
 3. Flat roofs shall be screened with parapets on all sides of the building. If no rooftop equipment exists or is proposed, the parapet shall be a minimum of 18 inches in height relative to the roof.
 4. Rooftop penthouse enclosures shall be architecturally compatible and predominately of the same material as the building.
- F. Roof-mounted mechanical units (including evaporative coolers, HVAC units, vents, etc.) shall be located or screened so they are not visible from adjacent public and/or private streets as well as from adjacent properties (unless grade differences make screening impractical). Acceptable roof equipment screening shall be accomplished by:
1. Raising the parapet on all sides of the building to be as high as the highest mechanical unit or vent on the roof; or

- 365
366
367
368
369
370
371
372
373
374
375
376
377
378
379
380
381
382
383
384
385
386
387
388
389
390
391
392
393
394
395
396
397
398
399
400
401
402
403
404
405
406
407
408
409
410
411
412
413
414
415
416
417
418
2. A secondary roof screening system (stamped and signed by a licensed engineer) to be as high as the highest mechanical unit or vent on the roof; and
 - a. Secondary roof screens shall include a screen which encloses groups of units rather than each unit individually and shall look like an architectural feature of the overall building;
 - b. Screens shall be continuously maintained, and incorporated into the design of the building;
 - c. Screens shall be made of materials and colors which are compatible with the building; and
 - d. In no case shall wooden, vinyl fences or chain link fencing with or without slats be used as a roof top equipment screen;
 3. All roof top mechanical screens shall be shown to scale on all building cross sections and/or architectural building elevations.
- G. Building Materials: Exterior materials shall be aesthetically pleasing, high quality, and compatible with nearby structures. Compatibility of building materials is deemed desirable throughout a development project consisting of multiple buildings.
1. Primary building materials shall be limited to no more than four (4) types of materials per building. Stucco (EIFS) surfacing shall not exceed 50% of each building exterior. Exterior windows or glass is included in calculating the overall percentage of the building exterior. On surfaces with more than 30% stucco (EIFS) coverage, a minimum of two (2) colors of stucco (EIFS) shall be provided;
 2. The use of exposed concrete, metal, or plastics for storefront facades is not permitted (architectural concrete and metals are acceptable);
 3. Metal siding is only permitted as a decorative and/or architectural element;
 4. CMU block (smooth, scored, split face, or honed) shall not exceed 25% of the front building façade and 50% of the sides of buildings which are within public view; and
 5. Building exterior materials shall be constructed of high quality materials and shall be factory finished, stained, integrally colored, or otherwise suitably treated.
- H. Building Colors: Exterior colors shall be aesthetically pleasing, high quality, and compatible with colors of nearby structures. Multiple buildings on the same site shall share a compatible color palette to unify the development.
1. Color of exterior building materials (excluding accent colors) shall be limited to no more than four (4) major colors per neighborhood within the "Retirement Community Property".
 2. Colors shall be composed predominately of earth tones to encourage buildings to blend into the environment. Color tones may vary if found to be compatible with surrounding developments; and
 3. Roof colors shall be muted and compatible with the dominant building color.
- I. Building Entrances: Primary building entrances shall be easily identifiable and relate to human scale.
1. The main entrance shall be located to be clearly identifiable from primary driveways and drop-offs;
 2. Any entrance shall be designed with one or more of the following (see Pedestrian Mobility, Bicycle Circulation and Parking 13.38.8B6:
 - a. Canopy, overhang or arch above the entrance (columns & pillars);
 - b. Recesses or projections in the building facade surrounding the entrance;
 - c. Peaked roof or raised parapet structures over the door; or
 - d. Display windows surrounding the entrance.
 3. Any building entrance shall be well-lighted. (see Exterior Site Lighting 13.38.11)

419 J. Energy Conservation Measures: Local climate conditions afford the opportunity to take significant
 420 advantage of passive and active solar energy applications. Buildings should be designed and sited to
 421 maximize the use of solar gain for energy savings, and shall respect the solar access requirements of
 422 adjacent (existing and proposed) buildings. Solar equipment is permitted subject to the standards set
 423 forth in 13.11.210 of the City Code.
 424

425 **13.38.5: Site Planning**

- 426 A. Purpose and Intent: Buildings shall be located to maximize the presentation of streetscaping and
 427 primary building entries to roadways, to provide clear orientation and access for both vehicles and
 428 pedestrians, to facilitate internal pedestrian circulation, and to place structures in consideration of
 429 the existing built context, the location of adjoining uses, and the location of roads.
 430
- 431 B. Building Siting and Orientation: Buildings shall be sited so the character of existing land forms and
 432 site features is enhanced; the relationships between buildings are strengthened; and pedestrian and
 433 vehicular circulation is facilitated.
 434
- 435 1. Sites shall be designed to allow for safe pedestrian access from parking areas to the
 436 building(s), from building to building, from the building(s) to adjacent developments and
 437 from building(s) to the public sidewalk. Every effort shall be made to minimize the need to
 438 walk within the parking lot among cars (see Pedestrian Mobility, Bicycle Circulation and
 439 Parking 13.38.8);
 - 440 2. The main entrance shall generally face the primary street and be easily identifiable from
 441 adjoining roadways and primary access drives;
 - 442 3. Secondary entrances may be located to the side or rear of a building to allow access to
 443 available parking.
 - 444 4. The rear or sides of buildings shall incorporate architectural and landscape screening
 445 techniques to mitigate the aesthetic impacts of blank walls, loading areas, storage areas,
 446 HVAC units and garbage receptacles (see Architectural Design 13.38.4 and Screen Walls and
 447 Fences 13.38.9).
 448
- 449 C. Building and Parking Setbacks: A well-landscaped and pedestrian-friendly character along streets
 450 which promotes a comfortable walkable environment is highly desirable. To attain this objective, all
 451 buildings and parking shall be set back from property lines and streets/right(s)-of-way a sufficient
 452 distance to create a distinct landscape zone between buildings, parking, and adjacent roadways.
 453 Setbacks shall be measured from the property line:
 454

Property Line Adjacent to:	Building Setbacks	Parking Setbacks
Residential Land Use	30 feet	20 feet
Non Residential Land Use	10 feet	10 feet
Open Space	10 feet	10 feet
Public Street/Right-of-Way	10 feet	10 feet
Bangerter Highway	30 feet	30 feet

- 455
- 456 D. Lot Regulations: Lots shall be of sufficient size and width to assure compliance with all requirements
 457 of the Taylorsville City Code.
- 458 E. Site Coverage Requirements: Open space and landscaped areas shall be deemed valued amenities.
 459 Building, parking, storage, and driveway site coverage within each parcel shall be limited in the
 460 following manner:
 461
- 462 1. The maximum building, parking, and driveway coverage within each parcel is 80% of the
 463 total lot area;

- 464 2. The minimum coverage for landscape improvements, pedestrian amenities, and bicycle
465 amenities within each parcel is 20% of the total lot area.
466 a. Pedestrian amenities include the following: hardscape plazas and walkways and outdoor
467 recreation areas.
468 b. Bicycle amenities include the following: Dedicated bicycle pathways or lanes completely
469 within the parcel, bicycle parking, bicycle lockers, employee showering and/or changing
470 facilities.
471 3. Storm water detention/retention areas may be included in landscape coverage if located
472 fully within the lot, and when those areas are effectively landscaped to satisfy the
473 requirements in this code. (see Landscape Design 13.38.5F).
474

475 F. Landscape Design

476 Landscaping shall be required within each building site to:

- 477
- 478 a. Enhance the aesthetics of developments;
 - 479 b. Create a pedestrian-friendly environment;
 - 480 c. Break up the mass of buildings;
 - 481 d. Soften architectural materials;
 - 482 e. Provide screening of service structures, storage, and loading areas;
 - 483 f. Enhance the streetscape environment;
 - 484 g. Define building and parking area entrances;
 - 485 h. Provide shade and climate control;
 - 486 i. Control airborne particulates;
 - 487 j. Provide buffers between incompatible land uses or site areas; and
 - 488 k. Filter drainage and storm water runoff from parking areas and streets.
- 489

490 This section provides four (4) distinct landscaping zones which correspond to the four (4) major
491 design influences on each site. The landscaping zones include:

- 492
- 493 i. Perimeter landscaping adjacent to public and private roads;
 - 494 ii. Perimeter landscaping adjacent to abutting property;
 - 495 iii. Parking lot landscaping; and
 - 496 iv. Building, loading, and service area landscaping.
- 497
- 498 1. Water Conservation: Water conservation concepts shall be considered in any landscaped
499 area. Generally, the highest intensity of materials, including variety, concentration, and
500 interest, shall be located along a public street and the front or main entrance to a building,
501 while the rear of a property, not abutting a public or private street, may receive a less
502 intensive landscape treatment. Drought tolerant plant species that are native to the region or
503 suitable to this climate are encouraged.
504
 - 505 2. Perimeter Landscaping Adjacent to Public Roads: The corridors along public streets shall
506 provide a visually cohesive open space system. Similar landscape treatments shall be used at
507 all entrances and intersections with appropriate plant materials, massing, spacing, and
508 height characteristics which reinforce the hierarchy of roadways. Planting and grading shall
509 work together to create a variety of experiences along these roadways and to call attention
510 to open space amenities. Perimeter edge treatments establish identity for the project and
511 shall convey a high quality image.
512
- 513 a. Annual and perennial gardens shall be planted at site entries.
 - 514 b. Street tree species shall vary in park strips but shall maintain the desired rhythm of
515 plantings by selecting trees with similar characteristics (i.e., height and branching
516 patterns).
 - 517 c. The following standards shall apply to all landscaped medians within the public right of
518 way:

519
520
521
522
523
524
525

- i. Provide a minimum of one (1) canopy tree for every 25 lineal feet of median, or space trees according to best practices.
- ii. Flowering plants, shrubs, and ornamental grasses shall be planted within the median at density deemed appropriate by the Planning Commission to provide visual interest and uniformity with the adjacent developments.
- iii. A detailed median landscape plan shall be submitted to city staff for review and approval by the Planning Commission (Refer to Figure 8 for example plan).

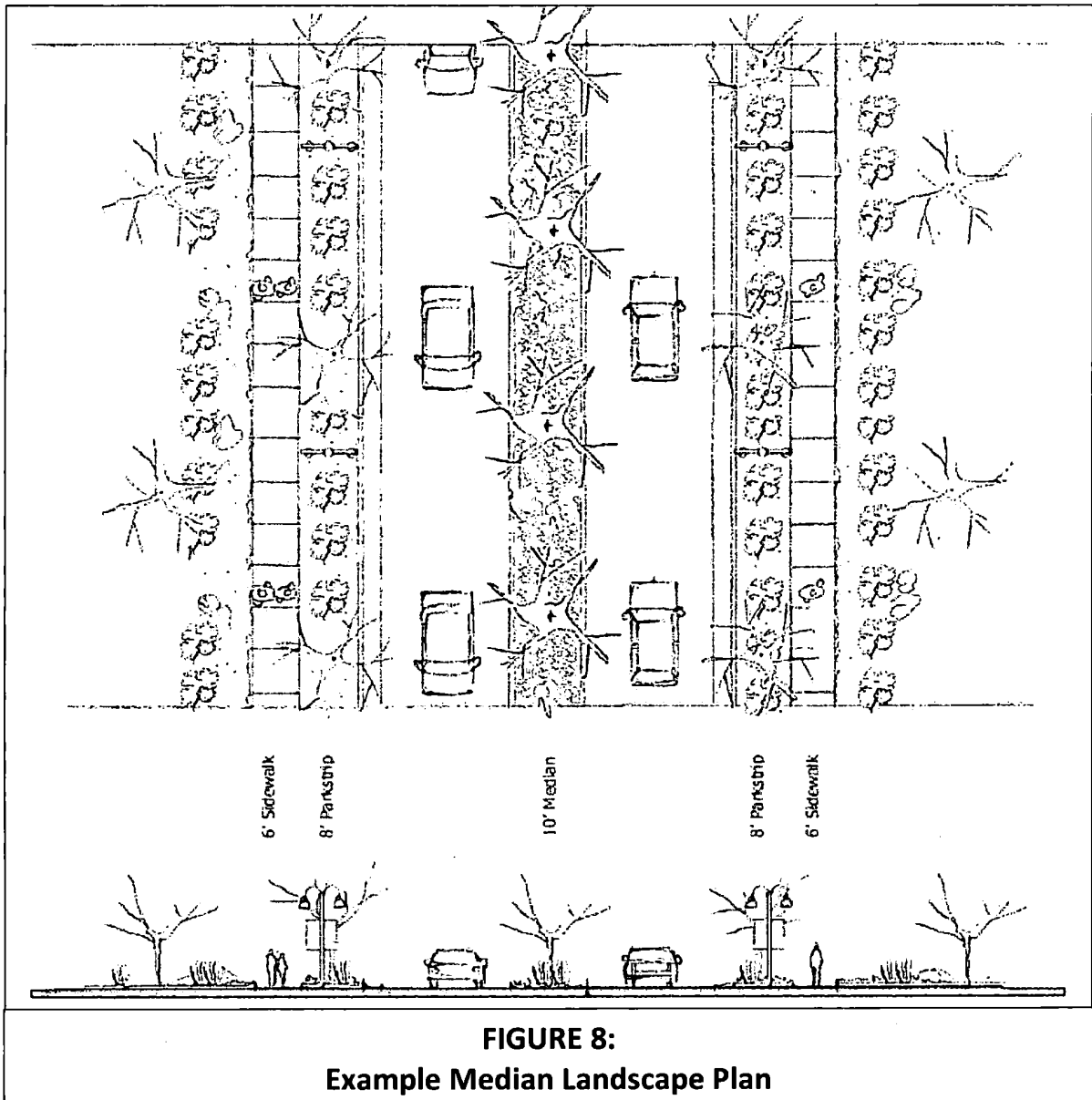

526
527
528
529
530

- d. The following standards shall apply to park strip and sidewalks adjacent to public streets (Refer to Figure 9). The Planning Commission may approve deviations from these standards if topography prohibits the literal application of the following standards:

- 531 i. Provide a minimum of one (1) tree per 40 lineal feet of public street frontage
 532 between the sidewalk and curb in a minimum eight (8) foot wide strip.
 533 ii. Provide durable, low growing shrubs/ornamental grasses at a minimum ratio of
 534 1 shrub/ornamental grass per five (5) lineal feet, durable ground covers or a
 535 combination of the two (2) between the curb and sidewalk. Irrigated turf may
 536 also be placed in these areas.
 537 iii. Provide an additional one (1) tree per 40 lineal feet of street frontage within a
 538 ten (10) foot landscape buffer outside the sidewalk, internal to the
 539 development.
 540 iv. Provide a minimum of one (1) shrub/ornamental grass per five (5) lineal feet
 541 plus ground cover or turf outside the sidewalk, internal to the development.
 542 Turf should be limited in this area and when used shall be planned in a manner
 543 that can be efficiently irrigated.

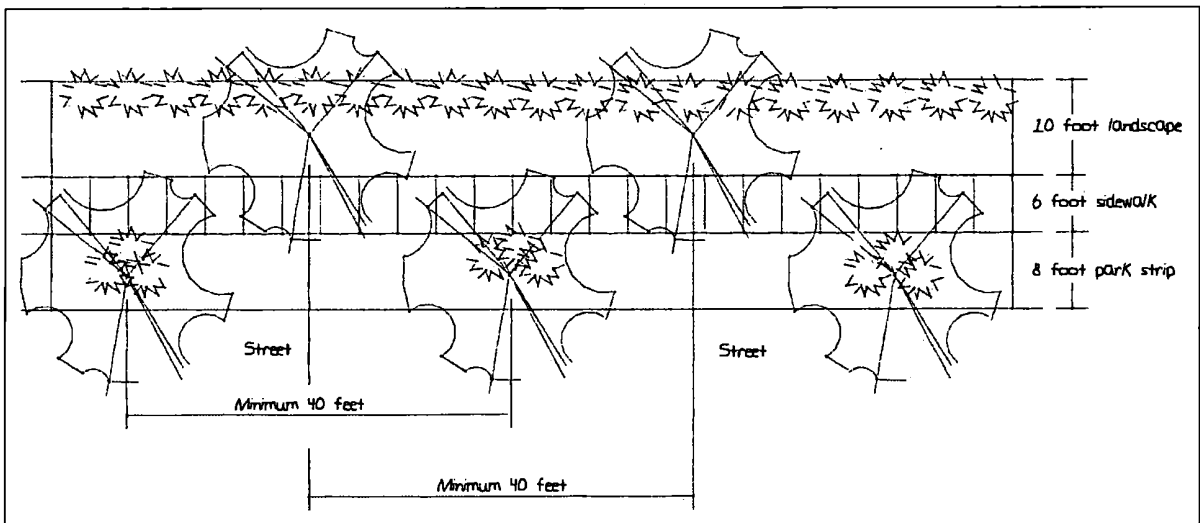
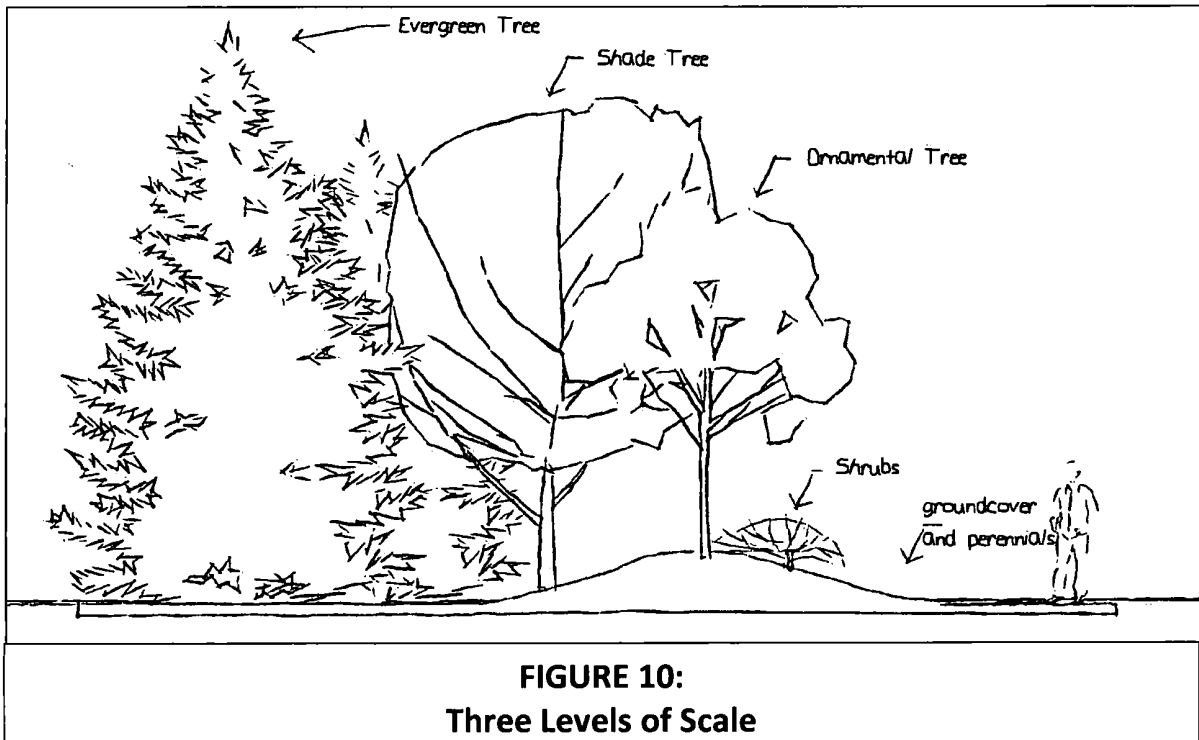

**FIGURE 9:
 Landscaping Example Adjacent to a Public Street**

- 544 v. To prevent interference with motorist visibility, parkway trees shall be planted
 545 a minimum of 3 feet from the back of curb. Shrubs/ornamental grasses shall not
 546 exceed 30" mature height.
 547
 548 e. Provide adequate shrub plantings to create a dense visual buffer between parking lots
 549 and perimeter roadways. Berming may be used in conjunction with vegetation to screen
 550 parking areas. Bermed turf areas should be avoided due to their tendency to waste
 551 irrigation water.
 552 f. Raised planters and screen walls are encouraged to provide parking lot screening.
 553 g. Adequate sight lines shall be maintained for an effective 30 foot sight triangle formed by
 554 the intersection of straight lines extended from the back of the curb (or future curb) and
 555 a line connecting them at points thirty feet (30') from the intersection of the curb line,
 556 except a reasonable number of trees pruned to permit unobstructed views to
 557 automobile drivers. Plants and signage are allowed within the sight triangle if:
 558
 559 i. Plants do not exceed 36" in height at full maturity; and
 560 ii. Signs do not exceed 36" in height (measured from top of curb height) unless
 561 they are 80 percent or more open.
 562

563
564
565
566
567
568
569
570
571
572
573
574

- h. Provide a diversity of landscaping materials at entry drives to development parcels. Therefore:
 - i. A minimum of three (3) levels of scale shall be provided, including: shade, evergreen, and/or ornamental trees, shrubs/ornamental grasses, annual and perennial flowers, and ground covers. (See Figure 10)
 - ii. Plant clusters which appear as a cohesive visual element, and that complement the overall landscape theme and palette.
 - iii. Integrate the plant design with the entry sign. Plantings should frame or provide a visual base for the signs.



575
576
577
578
579

580
581
582
583

- 3. For properties abutting Bangarter Highway, a minimum 30 foot wide landscape buffer area shall be provided along property lines (Refer to Figure 11). The minimum number of plants required within the landscape buffer is calculated by determining the length (in feet) of the property line(s) for which a buffer is required, dividing by 100 and then multiplying by the number of plants shown below:
 - a. Canopy Trees: ten (10);
 - b. Understory or evergreen trees: four (4); and
 - c. Evergreen trees and shrubs/ornamental grasses shall be implemented into the landscape design to provide adequate screening during all seasons.

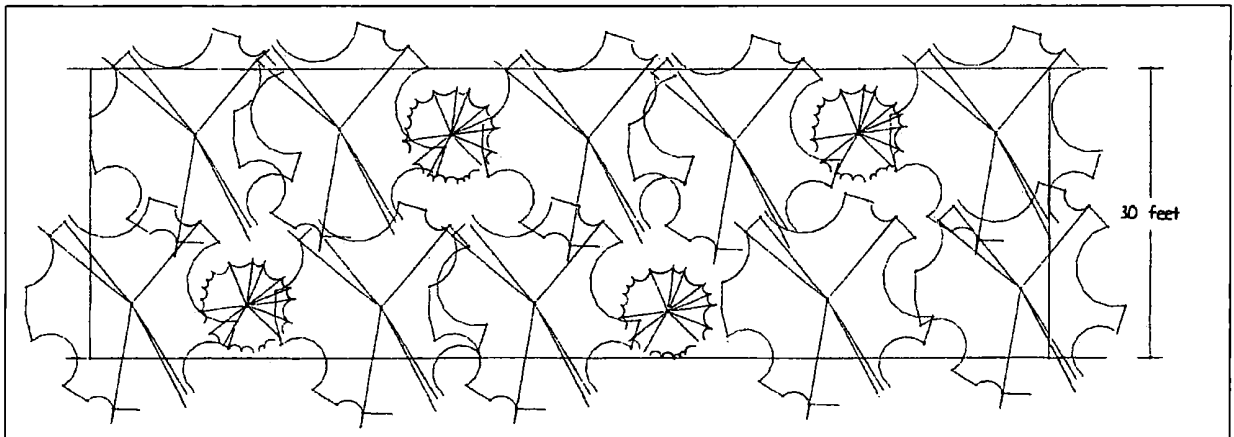
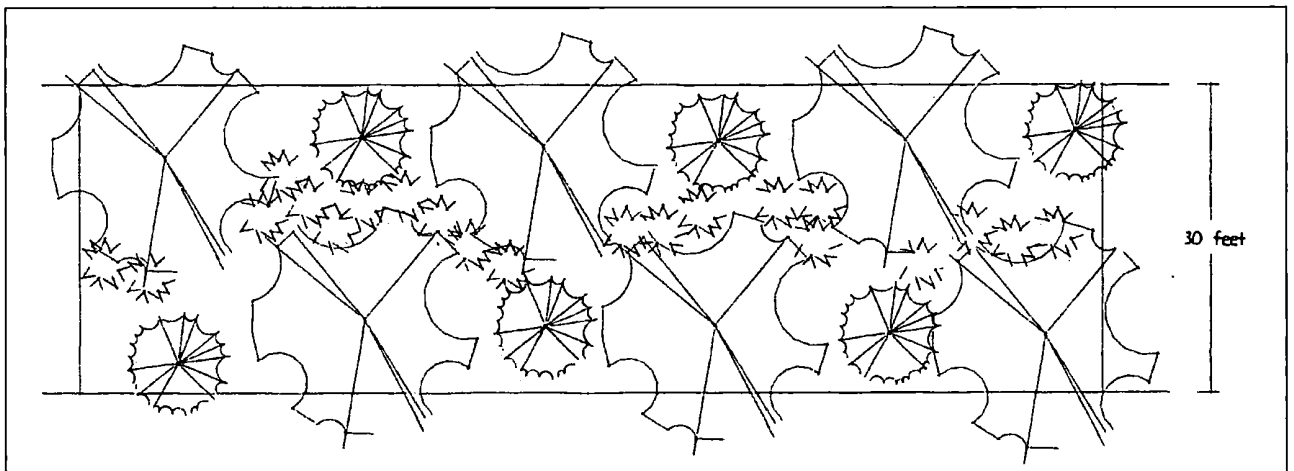

**FIGURE 11:
30' Landscape Buffer adjacent to Bangerter Highway**

585
586
587
588
589
590
591
592
593
594
595

596
597
598
599
600

4. Perimeter Landscaping Adjacent to Abutting Property: A visual buffer shall be provided between land uses to accomplish transitions and to mitigate potential conflicts between dissimilar uses. The provisions of this section require the following:
 - a. Abutting a residential land use: A minimum 30 foot wide landscape buffer area shall be provided along property lines (Refer to Figure 12). Where parking areas are effectively screened and adjacent to abutting residential property, the landscape buffer may be reduced to 20 feet. The minimum number of plants required within the landscape buffer is calculated by determining the length (in feet) of the property line(s) for which a buffer is required, dividing by 100 and then multiplying by the number of plants shown below:
 - i. Where a 30 foot landscape buffer is required:
 - a. Canopy Trees: six (6); and
 - b. Understory or evergreen trees: six (6); and
 - c. Deciduous or evergreen shrubs/ornamental grasses: twenty two (22);



**FIGURE 12:
30' Landscape Buffer adjacent to Residential Land Use**

- 601 ii. Where a 20 foot landscape buffer is required (Refer to Figure 13):
- 602 a. Canopy Trees: five (5); and
- 603 b. Understory or evergreen trees: three (3); and
- 604 c. Deciduous or evergreen shrubs/ornamental grasses: twenty two (22);
- 605
- 606 iii. Evergreen trees and shrubs/ornamental grasses shall be implemented into the
- 607 landscape design to provide adequate screening during all seasons.
- 608
- 609 iv. Berm(s) with a maximum 3:1 slope for sod areas or 2:1 for mulched areas shall
- be incorporated into the landscape buffer design.

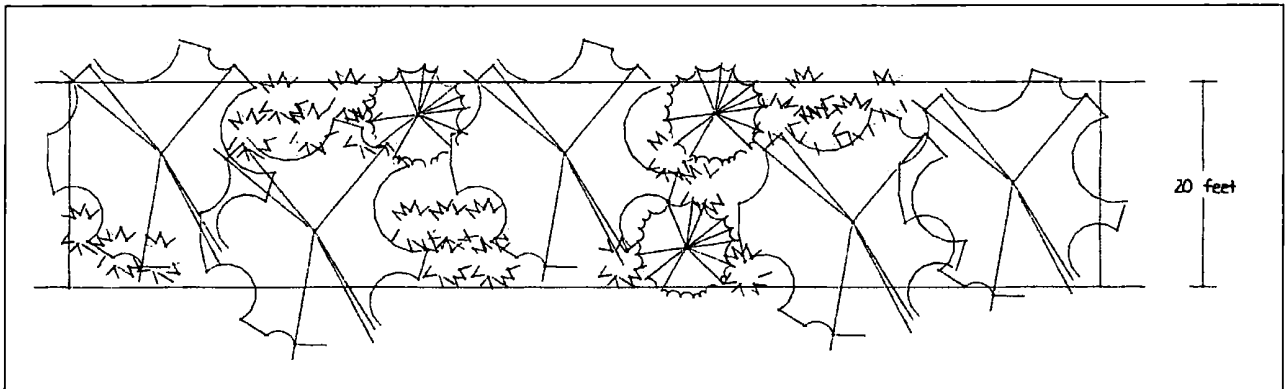

**FIGURE 13:
20' Landscape Buffer adjacent to Residential Land Use**

- 610 b. Abutting public open space: A minimum 10 foot wide landscape buffer area shall be
- 611 provided along property lines (Refer to Figure 14). The minimum number of plants
- 612 required within the landscape buffer is calculated by determining the length (in feet) of
- 613 the property line(s) for which a buffer is required, dividing by 100 and then multiplying
- 614 by the number of plants shown below:
 - 615 i. Canopy Trees: four (4);
 - 616 ii. Understory or evergreen trees: two (2);
 - 617 iii. Deciduous or evergreen shrubs/ornamental grasses: eleven (11);
 - 618 iv. Evergreen trees and shrubs/ornamental grasses shall be implemented into the
 - 619 landscape design to provide adequate screening during all seasons.
- 620 c. Abutting a nonresidential zoning district: A minimum ten (10) foot wide landscape
- 621 buffer area shall be provided along property lines (Refer to Figure 14). This may not
- 622 apply to internal property boundaries within a multiple-lot development to the extent
- 623 the lots are developed under a single master plan. The minimum number of plants
- 624 required within the landscape buffer is calculated by determining the length (in feet) of
- 625 the property line(s) for which a buffer is required, dividing by 100 and then multiplying
- 626 by the number of plants shown below:
 - 627 i. Canopy trees: four (4)
 - 628 ii. Understory or evergreen trees: two (2); and
 - 629 iii. Deciduous or evergreen shrubs/ornamental grasses: eleven (11).
 - 630 iv. Berm(s) with a maximum 3:1 slope for sod areas or 2:1 for mulched areas shall
 - 631 be incorporated into the landscape buffer design.
 - 632 v. Evergreen trees and shrubs/ornamental grasses shall be implemented into the
 - 633 landscape design to provide adequate screening during all seasons.
 - 634

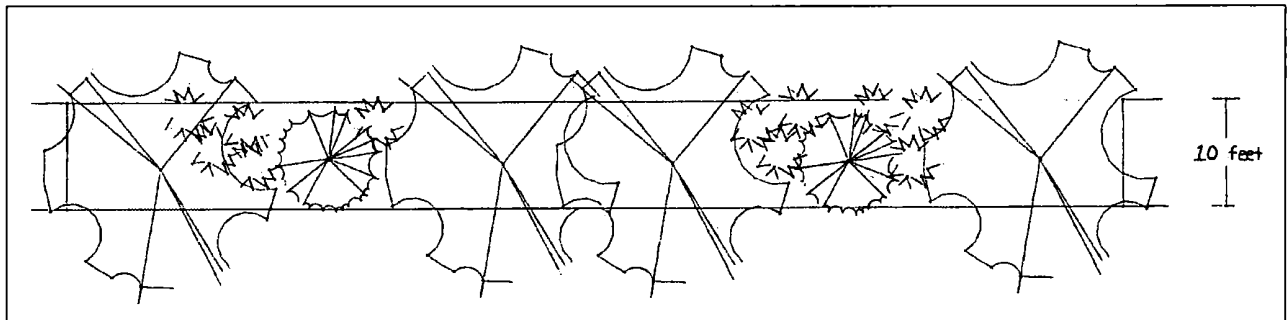

**FIGURE 14:
10' Landscape Buffer adjacent to Non Residential Land Use or Open Space**

635
636
637
638
639
640
641
642
643
644
645
646
647
648
649
650
651

5. Parking Lot Landscaping: Parking lots shall be designed to blend with each building site's character using landscape plantings and grading, and not be readily visible from public rights of way. The provisions of this section require the following:
 - a. Landscape Islands On Double Rows Of Parking:
 - i. There shall be one (1) landscaped island a minimum of nine (9) feet wide and equal to the length of the parking spaces on each end of the parking rows, with an additional island every twentieth (20th) parking stall in the same row where each island has a minimum of two (2) trees and eight (8) shrubs/ornamental grasses per tree; and
 - ii. There shall be one (1) tree diamond (minimum 5'x5') every third (3rd) parking stall in the same row (see Figure 15); or
 - iii. A landscaped median between parking rows a minimum of eight (8) feet wide with one (1) tree every 25 linear feet with eight (8) shrubs/ornamental grasses per tree (see Figure 16).

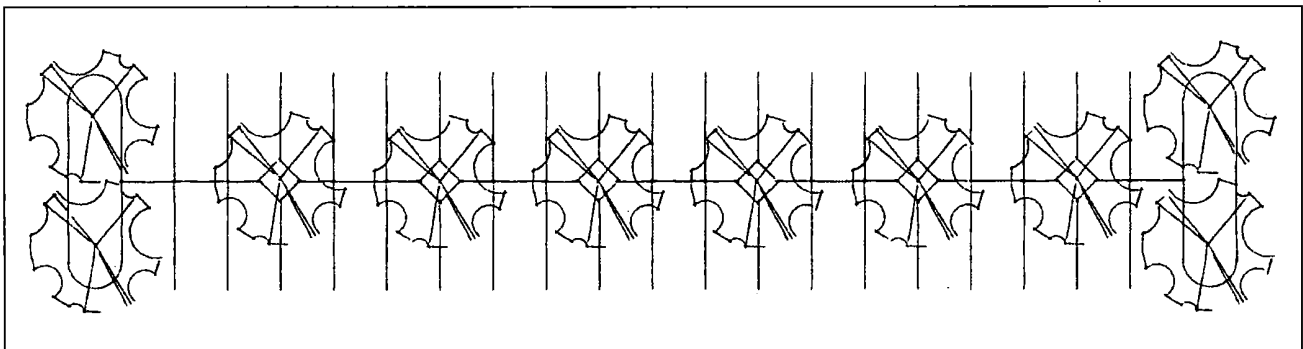

**FIGURE 15:
Parking Lot Tree Diamond Example**

652
653
654
655
656
657

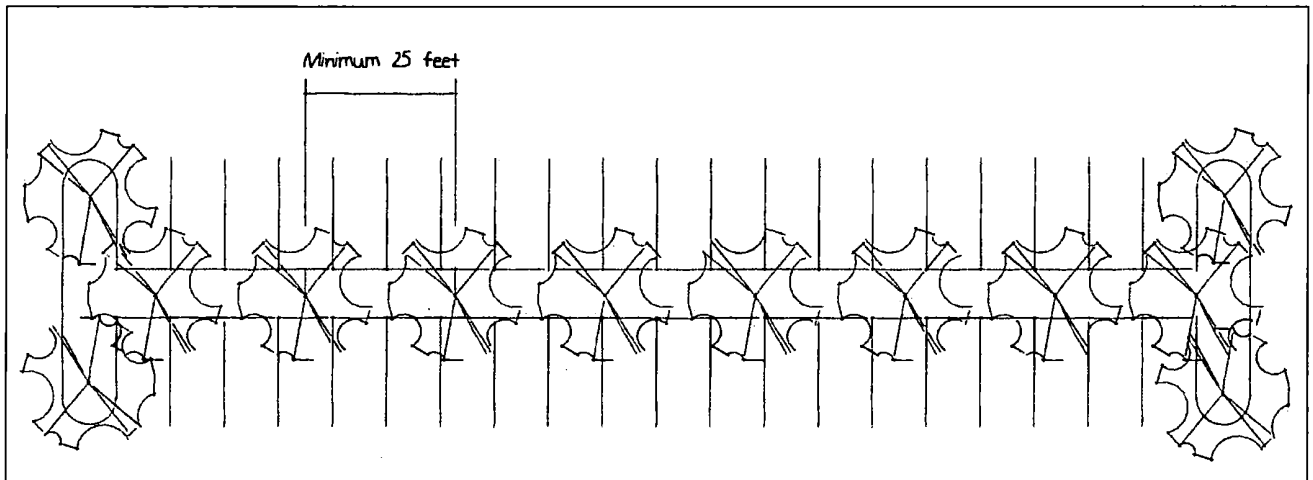

**FIGURE 16:
Parking Lot 8 foot Landscape Median Example**

658
659
660
661
662
663
664
665
666
667
668
669
670
671
672
673
674
675
676
677
678
679
680
681
682
683
684
685
686
687
688
689
690
691
692

- b. Landscape Islands On Single Rows Of Parking:
- c. On single rows of parking or where parking abuts a sidewalk, there shall be one (1) landscape island a minimum of nine (9) feet wide and equal to the length of the parking space on each end of the parking row with an additional island every twentieth (20th) stall in the same row where each island has a minimum of one (1) tree and eight (8) shrubs/ornamental grasses.
 - Landscape Islands At Ends Of Parking Rows:
 - i. Landscaped islands at the ends of parking rows shall be placed and shaped in such a manner as to help direct traffic through the parking area; and
 - ii. There shall be a break in parking rows every thirtieth (30th) parking stall in the same row for the purpose of facilitating traffic circulation on the site via drive aisles.
- d. Landscaped Medians:
 - i. Place landscape medians a minimum of ten (10) feet wide between every other parking aisle in lots with 100 or more parking stalls. Landscape medians shall include a minimum six (6) foot wide sidewalk with a minimum two (2) foot landscaped area on either side. For instances where parking rows are parallel with the primary building façade, a minimum six (6) foot wide pedestrian walkway shall be provided to link the parking area to the building entrance.
 - ii. Provide a minimum of 1 canopy shade tree for each 25 lineal feet of median, or according to best practices.
 - iii. Each landscape median shall have either a minimum of ten (10) shrubs/ornamental grasses per 30 lineal feet and/or a durable and hardy ground cover.
- e. Where forward motion parking occurs, all shrubs/ornamental grasses shall be located at a minimum of three (3) feet from the edge of the parking lot curb.
- f. No landscaped area within a parking lot shall be less than 100 square feet with the exception of a tree diamond.

- 693
694
695
696
697
698
699
700
701
702
703
704
705
706
707
708
709
710
711
712
713
714
715
716
717
718
719
720
721
722
723
724
725
726
727
728
729
730
731
732
733
734
735
736
737
738
739
740
741
742
743
744
745
746
747
6. Building Site Landscaping: The coordination of landscape design for individual building sites is deemed essential for creating a consistent, high-quality character, which coordinated design unifies the various buildings and strengthens the cohesiveness of the development. It shall be required to:
 - a. Except where features such as arcades, entry ways, or pedestrian plazas are part of the facade, provide a six (6) foot wide planting bed between the front façade of the building and the adjacent pedestrian walkway.
 7. Landscape Irrigation/Water Conservation: Reasonable effort shall be made to conserve water by utilizing alternative means for maintaining a suitable landscape environment. Low water use and water conservation concepts may be incorporated into the landscape design of each development without compromising the intent to establish significant visual amenities through landscaping.
 8. Landscape Standards and Plant Material Selection: Random spotting of many different plant types is deemed inappropriate. Planting shall reinforce the site planning concepts and complement architectural forms. The following provisions shall govern this section:
 - a. Any landscape plans shall be prepared by a licensed professional.
 - b. The installation of any landscaping shall be done by a licensed landscape contractor;
 - c. Artificial plants of any type, size or color are prohibited as exterior landscaping within any lot.
 - d. Mulching:
 - i. Any planting bed may be mulched with wood, decorative rock, or other ground cover approved by the Director to stabilize soils, control erosion, and conserve water use; and
 - ii. A minimum of one (1) shrub/ornamental grass per 25 square feet of wood mulch, decorative rock, or other approved ground cover shall be provided; and
 - iii. Rock mulch shall vary in size and coloration, but is restricted to less than three inches (3") in size.
 - e. Use of landscape or weed barrier fabric shall be required within all planter beds and mulched areas to control weeds.
 - f. Parking is prohibited within landscaped areas on a site.
 - g. Please contact the Taylorsville Community Development Department for a list of recommended plant materials.
 9. Plant Size Standards: An immediate landscape impact is deemed desirable within any development thereby incorporating minimum plant-size standards. Height and caliper measured by ANSI standard Z60.1.

Deciduous shade/canopy trees	2.0" caliper;
Ornamental trees	2.0" caliper;
Evergreen trees	6'-8' height;
Multi-Stem Ornamentals	8'-10' height;
Shrubs	50% shall be ≥ 5 gallon container;
Ornamental Grasses	50% shall be ≥ 1 gallon container;
Vines	1 gallon container; or
Ground Cover/Perennials	2 ¼" pots
 10. Landscape Maintenance and Replacement: The property owner shall be responsible for providing, protecting and maintaining landscaping in a healthy and growing condition. The following requirements shall be noted on the landscape plan:

748
749
750
751
752
753
754
755
756
757
758
759
760
761
762
763
764
765
766
767
768
769
770
771
772
773
774
775
776
777
778
779
780
781
782
783
784
785
786
787
788
789
790
791
792
793
794
795
796
797
798
799
800
801
802

- a. The property owner shall remove and replace dead or diseased plant materials within reasonable time or within one (1) month, with the same type, size and quantity of plant material as originally installed unless incompatible with the soil or weather conditions; and
- b. Landscape materials located in the public right of way shall be maintained by the abutting property owner or as defined in the Development Agreement.

11. Site Furniture and Features: Site furnishings include benches, waste receptacles, planters, railings and bollards. Visual consistency of these elements is desired throughout each development. All components of outdoor site furniture should be low maintenance, highly durable and resistant to vandalism, graffiti, and theft.

- a. Outdoor Seating:
 - i. Use outdoor seating that is comfortable, attractive, durable and easy to maintain.
 - ii. Locate benches at major building entryways, drop-off areas, transit stops, pedestrian courtyards and plazas.
- b. Planters and Waste Receptacles:
 - i. Design planters and waste receptacles to coordinate with other furniture.
 - ii. Use materials and colors similar to those used for benches.
- c. Tree Grates:
 - i. Use of tree grates is discouraged unless used in conjunction with structural soils. If necessary, use tree grates to prevent excessive soil compaction and to give added interest to the pavement.
 - ii. Choose tree grates that are fabricated of a strong, durable material. In areas which receive heavy use, tree guards may be appropriate to give added protection to young trees.

G. Utilities and Mechanical Equipment: The visual and noise impacts of utilities and mechanical equipment shall be mitigated in the following manner and shall apply to all public and private rights-of-way and pedestrian areas within the development:

- 1. All new permanent utility lines shall be installed underground;
- 2. Abandoned utility boxes, meters and pedestals shall be removed;
- 3. Damaged utility boxes, meters, and pedestals shall be repaired;
- 4. Utility box and pedestals shall be placed such that they do not block pedestrian travel or required visibility triangles at street intersections and driveways;
- 5. Utility boxes, pedestals, and meter panels shall be painted to blend in with its immediate surroundings. All utility boxes and meter panels on walls shall be painted to match the building walls (subject to utility company approvals); and
- 6. All utility boxes and pedestals shall be screened from view by means of vegetation or enclosures to minimize visual and auditory impacts. Such enclosures or landscaping treatments shall be consistent with the design theme of the development.

H. Service, Refuse, Delivery, and Storage Areas: Service, delivery, refuse and storage areas shall not be visually obtrusive. The visual impact of such areas shall be minimized; especially views of such areas from public or private roadways, pedestrian walkways, and pedestrian bikeways. The following shall apply:

- 1. Locate service, delivery, and storage areas a minimum of 20 feet from any public right of way in areas of low visibility, such as the non-street side or the rear of buildings;
- 2. Such areas and other similar uses shall be oriented toward service access and away from all adjoining roadways, pedestrian walkways, and pedestrian bikeways unless adequately screened (see Screen Walls and Fences, 13.38.9);

- 803
804
805
806
807
808
809
810
3. Service entrances and trash dumpsters shall be screened from public streets, pedestrian gathering areas and primary entrances with fencing, walls and/or landscaping. If fencing or walls are used they shall be made of materials employed elsewhere on the building or site.
 4. Refuse collection areas shall be designed to include the screening of large items (e.g. skids and pallets) as well as trash bin(s) to accommodate the primary land use which they serve.
 5. Only items which are associated with the specific operation or land use occupying the building may be kept in refuse collection areas.

811 **13.38.6: Grading and Drainage**

- 812
813
814
815
816
817
818
819
820
821
822
823
824
825
826
827
- A. Water Quality Control + Drainage: All projects shall implement appropriate measures to mitigate negative impacts on the storm sewer system and adjacent waterways and properties. Storm water retention is encouraged on site when possible. Water quality control and drainage proposals shall be approved by the City Engineer.
 - B. Site Grading and Excavation: Buildings shall be designed to relate to existing grade conditions and to minimize cut-and-fill on-site. The following shall apply:
 1. Site grading designs shall allow for easy pedestrian access from sidewalks, pathways, trails, and parking areas.
 2. Where building foundation walls are exposed, they shall be faced with a decorative material such as brick or stone.
 3. Modification to existing site topography shall be permitted where and to the extent that it contributes to good design and shall be executed in such a manner to avoid drainage impacts (such as erosion and road damage), both on-site and downstream.

828 **13.38.7: Vehicular Circulation and Parking**

- 829
830
831
832
833
834
835
836
837
838
839
840
841
842
843
844
845
846
847
848
849
850
851
852
853
854
855
856
- A. Purpose and Intent: The on-site vehicular circulation and parking system is deemed a critical factor in the safety and success of any development. The parking/access/circulation systems provide for the safe, efficient, convenient, and functional movement of multiple modes of transportation both on and off the site where pedestrian/bicycle/vehicle conflicts are minimized. The site planning process shall make provisions for alternate modes of transportation, including public transit, bicycles and pedestrian movement.
 - B. Vehicular Access: The City shall promote the safety and mobility of through-traffic by minimizing the number of access points to private property from public streets, which shall include the following measures:
 1. Driveways shall be not less than twelve feet (12') wide for one way travel, nor more than thirty five feet (35') in width for two way travel. A wider driveway may be required by applicable fire authority. The curb opening or width of each driveway shall be defined as the throat width of the driveway at the inside point of the curb transition radius at the top face of the curb.
 2. The number of driveways per street frontage for a lot is determined by the length of the lot frontage, as measured at the front property line. Lots shall be permitted access onto the adjacent streets according to their functional classification as follows:
 - a. Arterial: One (1) driveway per 800 feet of street frontage, not to exceed two (2) driveways; or if the lot has less than 800 feet of street frontage, one (1) driveway per lot;
 - b. Collector: One (1) driveway per 300 feet of street frontage, not to exceed three (3) driveways; or if the lot has less than 300 feet of street frontage, one (1) driveway per lot;
 - c. Local or Private Street: One (1) driveway per building lot, not to exceed two (2) driveways; and
 - d. Additional driveways may be permitted when a capacity or safety need for more than one driveway opening can be demonstrated to the city transportation engineer. This may be determined on a case by case basis.

- 857
858
859
860
861
862
863
864
865
866
867
868
869
870
871
872
873
874
875
876
877
878
879
880
881
882
883
884
885
886
887
888
889
890
891
892
893
894
895
896
897
898
899
900
901
902
903
904
905
906
907
908
909
910
911
3. No driveway shall be closer than 50 feet to the point of the intersection of two (2) property lines at any corner of two (2) local or private streets as measured along the property line;
 4. No driveway shall be closer than 150 feet to the point of intersection of two (2) property lines at any corner where either street is a major collector or arterial as measured along the property line;
 5. Driveways on the same side of a street shall be separated by a minimum 100 foot distance;
 6. The city engineer shall review and may approve or deny deviations to the driveway separation standards based upon a site visit and review of items including, but not limited to:
 - a. Safety;
 - b. Alternative access points and potential for reciprocal/shared access;
 - c. Sight lines; and
 - d. Impact on traffic flow.
 7. Shared driveways located on the property line of two (2) building lots require evidence that an access easement is in place providing for joint use of the shared driveway;
 8. When a development is built in phases, each phase shall include the minimum number of parking stalls, necessary driveways, and access points required for the uses proposed in that phase of construction.
 9. The perimeter of all paved surfaces shall be finished with six inch (6") high concrete curbing with handicap ramps, where necessary.
 10. Where an entry gate or guardhouse controls vehicle access or egress, a stacking lane shall be provided as required by the city engineer. The stacking lane shall not interfere with maneuvering, traffic flow of aisles, streets, bike paths, parking spaces and sidewalks.
- C. Vehicular Circulation: Projects with multiple building sites or parcels shall include a hierarchy of internal roadways such as: 1) Internal Collector 2) Internal Drives 4) Parking Aisles; and 3) Service Drives. The street, access and parking network shall provide for the smooth, safe, convenient and functional movement of all modes of transportation, including vehicles, public transit, bikes and pedestrians, which shall include the following measures:
1. Where dead-end pathways, sidewalks, bikeways, or "stub streets" terminate at a property line, linkages shall be provided to connect developments with surrounding areas. This requirement may be waived by the Planning Commission for private developments which include a secure and gated access entry point(s).
 2. Truck and vehicle backing from a public street onto the site for loading or any other purpose shall be prohibited; and
 3. Vehicle circulation routes requiring movement onto a public street in order to move from one area to another on the same building site shall be prohibited.
- D. Service/Delivery and Emergency Access: Service circulation within a development shall be designed to provide safe movements for all anticipated vehicles. The design of individual lots to accommodate truck access shall meet all regulatory requirements for turning radii without sacrificing other standards.
1. Lots shall include the necessary dimensions for the on-site maneuvering of refuse vehicles and firetrucks as determined by the city engineer and applicable fire authority; a minimum twenty foot (20') wide, unobstructed driveway, lane, or other access way and turnaround may be required for this purpose;
 2. No off site maneuvering is permitted;
 3. At least one (1) off street loading space shall be provided and maintained on the same lot with every building or part thereof having a gross floor area of ten thousand (10,000) square feet or more, that is to be occupied by a commercial or industrial use, to or from which delivery of materials or merchandise are regularly made by a motor vehicle;
 4. Off street loading spaces may not block use of required parking space areas of site or adjacent sites; and

- 912 5. Each loading area shall be not less than twelve feet (12') wide, twenty five feet (25') long,
 913 and if enclosed or covered, fourteen feet (14') high. Adequate turning and maneuvering
 914 space must be provided on the site.
 915
- 916 E. Parking Lots: Vehicle parking shall be provided to meet the location and quantity requirements of
 917 specific uses without detracting from the creation of attractive pedestrian environments in the
 918 following manner:
 919
- 920 1. Parking lots shall be designed with a hierarchy of circulation: 1) Internal Collector 2)
 921 Internal Drives 3) Parking Aisles; and 4) Service Drives (if applicable).
 - 922 2. The periphery of all surface parking areas shall be designed to screen automobiles from view
 923 from a public or private street. A developer may screen using one or a combination of the
 924 following techniques:
 925 a. Decorative walls up to three (3) feet in height;
 926 b. A combination of berming and vegetation which provides a dense visual buffer.
 - 927 3. Parking areas with 200 or more parking stalls shall be divided by buildings or a landscaped
 928 area(s) which are a minimum of ten (10) feet wide and the length of the parking area being
 929 divided.
 - 930 4. Adequate space for unimpeded turn-around shall be provided at dead-end aisles;
 - 931 5. Parking areas shall incorporate pedestrian walkways in a manner that links buildings to the
 932 street sidewalk system by either a raised concrete walkway or pedestrian plaza and
 933 landscaped strip (see Pedestrian Mobility, Bicycle Circulation and Parking, 13.38.8B);
 - 934 6. Each parking space shall comply with the following parking stall dimensions:
 935
 936 a. Minimum Parking Layout Dimensions:

Label	Design Component		Parking Angle				
			0° (Parallel)	30°	45°	60°	90°
A	Stall Width		9'(8') ¹	9'	9'	9'	9'
B	Stall Length		22'	18'	18'	18'	18'
C	Stall Width Parallel to Aisle		N/A	18'-0"	12'-9"	10'-5"	9'-0"
D	Stall Depth to Curb or Wall		N/A	16'-10"	19'-1"	20'-1"	18'-0"
E	Stall Depth to Interlock		N/A	12'-11"	15'-11"	17'-10"	18'-0"
F	Aisle Width ²	One-Way	13'	14'	16'	19'	N/A
		Two-Way	24'	22'	24'	24'	26'
G	Module Width Wall/Curb to Interlock	One-Way Aisle	N/A	43'-9"	51'-0"	46'-11"	N/A
		Two-Way Aisle	N/A	51'-9"	59'-0"	61'-11"	62'-0"
H	Module Width Interlock to Interlock	One-Way Aisle	N/A	39'-10"	47'-10"	54'-8"	N/A
		Two-Way Aisle	N/A	47'-10"	55'-10"	59'-8"	62'-0"
not shown in Figure 3	Module Width Wall/Curb to Wall/Curb	One-Way Aisle	31'-0"	47'-8"	54'-2"	59'-2"	N/A
		Two-Way Aisle	42'-0"	55'-8"	62'-2"	64'-2"	62'-0"
I	Cross Aisle Width ²	One-Way	15'	15'	15'	15'	15'
		Two-Way	22'	22'	22'	22'	22'

¹ 8' width applies to on-street parking stalls

² The Director may require greater aisle width due to emergency equipment needs. Aisles less than 24' shall not be designated as Fire Access.

N/A – Not Applicable

937

FIGURE 17:
Reference Drawing for Minimum Parking Layout Dimensions

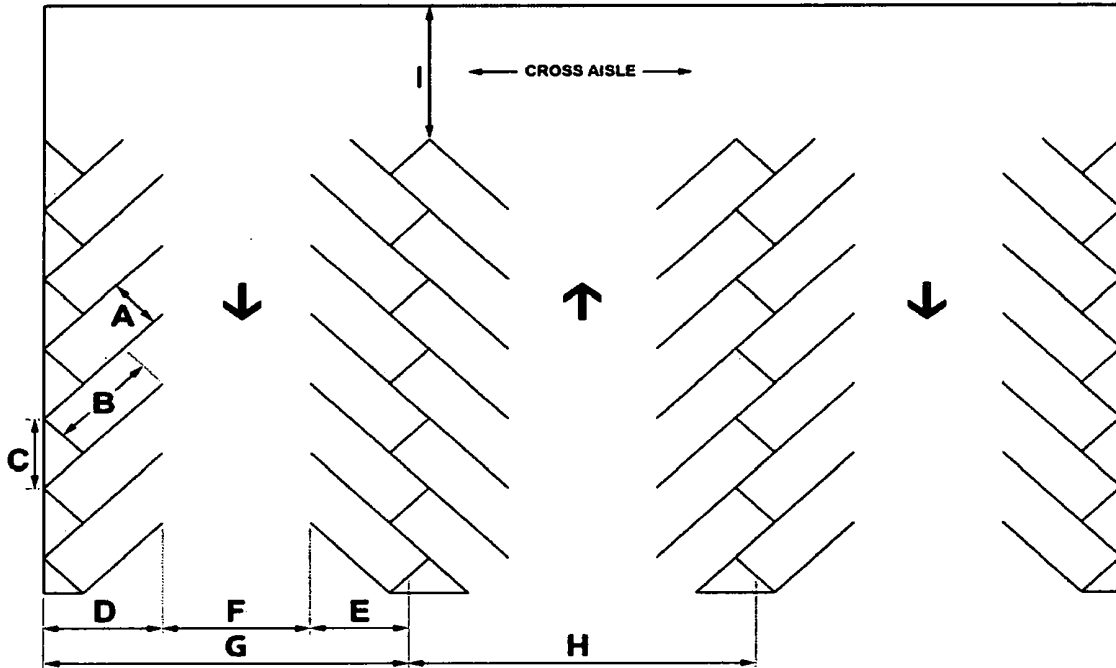

938
939
940
941
942
943

FIGURE 18:
Minimum Dimensions for Common Parking Lot Layouts

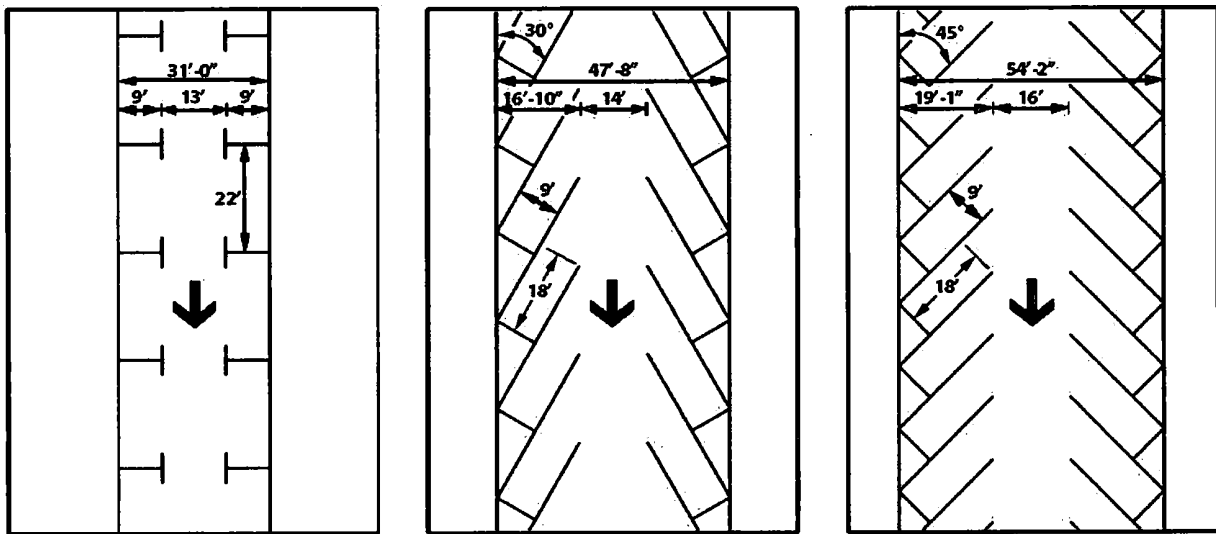

0° Parallel Parking Spaces

30° Parking Spaces

45° Parking Spaces

**FIGURE 19:
Minimum Dimensions for Common Parking Lot Layouts**

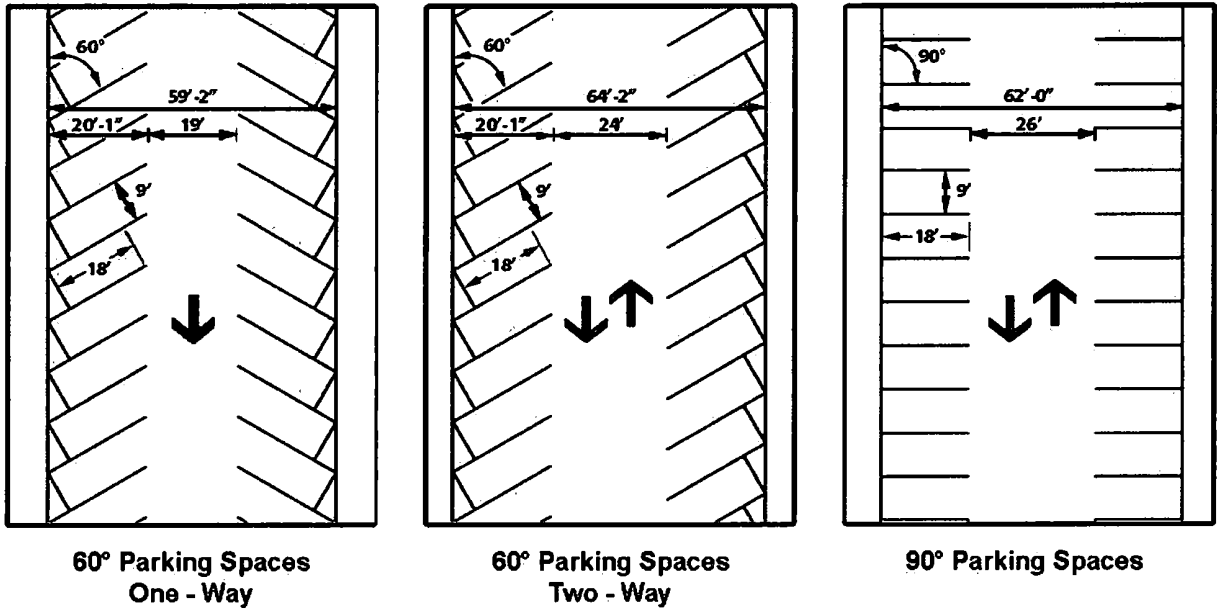

944
945
946
947
948
949
950
951
952
953
954
955

7. An appropriate number of handicap spaces shall be provided on the building site as provided in 13.24.070 of the City Code.
8. On-street parking spaces immediately adjacent to the site may be credited toward parking requirements if such parking is identified and approved during the site plan review and approval process; and
9. For parking lot landscaping standards, see Landscape Design, 13.38.5F5.
10. Minimum and Maximum Parking Ratios: Parking requirements shall be met as provided in the following table:

Land Use	Minimum Parking Ratio	Maximum Parking Ratio
Nursing Home or other similar uses	0.25 stall per bed, plus 1 per employee on a peak shift	0.25 stall per bed, plus 1 per employee on a peak shift
Professional Office	3.0 spaces per 1,000 square feet of floor area	4.0 spaces per 1,000 square feet of floor area
Senior Citizen (assisted)	1 stall per 2 dwelling or sleeping units	1 stall per 2 dwelling or sleeping units
Senior Citizen (independent)	1 stall per dwelling unit (20% of stalls shall be covered)	1.5 stall per dwelling unit (20% of stalls shall be covered)

956
957
958
959
960
961
962

11. The maximum number of parking stalls on a site may be increased by 25% subject to the following:
 - a. A minimum of 20% of the total parking area is landscaped; and
 - b. A tree to parking stall ratio of 0.25 to 1 is provided within the parking area; or
 - c. A minimum of 25% of the total parking stalls on site are within a parking structure or below grade.

- 963
964
965
966
967
968
969
970
971
972
973
974
975
976
977
978
979
980
981
982
983
984
985
986
987
988
989
990
991
992
993
994
995
996
997
998
999
1000
1001
1002
1003
1004
1005
1006
1007
1008
1009
1010
1011
1012
1013
1014
1015
1016
1017
12. The minimum number of parking stalls on a site may be decreased subject to the following:
 - a. The number of stalls required for a site may be decreased by 20% if a minimum of 20% of the total parking area is landscaped; and
 - b. A tree to parking stall ratio of 0.25 to 1 is provided within the parking area; or
 - c. A minimum of 25% of the total parking stalls on site are within a parking structure or below grade; or
 - d. If a transit shelter, bus turn-around, or other transit improvement is provided which satisfies City standards and provides seating and shelter, the minimum parking requirement may be reduced by 5%. To qualify, the land use requesting the decrease shall be located within 600 feet of a transit stop with a maximum 30 minute headway. Installation of transit facilities requires written approval from the transit agency.
 13. All parking or service areas shall be paved with a solid surface and shall be arranged and striped to provide orderly and safe loading, unloading, and parking of vehicles. The city engineer and community development director shall review and may approve or deny other types of surfacing materials.
 14. Parking lot striping shall be maintained on a regular basis so that striping is visible for the safe ingress/egress and parking of vehicles.
 15. Shared Parking: Notwithstanding any other parking requirements provided in this chapter, when land uses occupy the same lot or adjacent lots, the total number of off street parking spaces required for each use may be combined and shared. A proposal for sharing off street parking shall be presented to the community development director. If the proposal involves the accommodation of more than ten (10) parking spaces (total accumulated spaces required for all involved uses), the director may present the proposal to the planning commission for site plan review. In order to qualify for shared parking, applicants shall present the following:
 - a. The location and identity of each use that will share the facility.
 - b. The total parking requirement for each use.
 - c. The projected hours of operation of each use and the hours during which the peak parking demand will be experienced.
 - d. The number of existing and/or proposed parking spaces.
 - e. A site plan that provides for a distance of no greater than five hundred feet (500') from the nearest entrance of each use to the nearest edge of the parking facility.
 - f. A site plan that demonstrates that the proposed shared parking facility will comply with all standards required by this code for parking lot development.
- F. Parking Structures and Parking Beneath Buildings: The appearance of parking structures, whether freestanding or attached, shall relate to the buildings they serve and contribute to the character of the development. The incorporation of parking structures in a commercial development is encouraged in order to minimize site coverage. The following standards shall apply:
1. The general architectural criteria shall apply to all parking structures (see Architectural Design 13.38.4). Design features shall include the same finish materials as the exterior of the building on the site.
 2. Pedestrian connections between parking structures and main buildings shall be provided. Connections shall be separated from vehicular travel areas, well lit, and convenient.
 3. Any parking structure shall be landscaped at the base of the facility with trees and shrubs/ornamental grass, along with other materials that will deemphasize the use of the facility as a parking structure and adequately mitigate adverse visual impacts. It is strongly encouraged, but not required, to landscape the top level with trees, grass, and other pedestrian friendly elements.
- G. Future Parking Lots and Structures: Projects which are expected to be developed in phases shall anticipate and accommodate such phasing in the parking lot design. Increased parking demands shall relate to anticipated expansions.

- 1018 1. Where expansion is planned, appropriate amounts of land for additional parking shall be
1019 reserved at the outset.
1020
1021 H. Mass Transit Facilities: Transit facilities shall be accommodated within all mixed use developments
1022 as approved by the serving agency. Transit routes, access points and shelter locations should be
1023 addressed along major roadways within and on the perimeter of such projects. Transit facilities shall
1024 be provided in a manner to make transit an attractive mode of travel for both employees and patrons.
1025

1026 **13.38.8: Pedestrian Mobility, Bicycle Circulation and Parking**

- 1027 A. Purpose and Intent: Pedestrian and bicycle systems shall be designed to be safe and to encourage
1028 walking and bicycling throughout the project. Individual lots shall be integrated with adjacent
1029 properties designed to form a comprehensive system and to provide convenient access to transit
1030 stops and trail systems. Pedestrian spaces and routes shall be designed to invite walking to and from
1031 each development. Routes shall be integrated to form a comprehensive circulation system, providing
1032 convenient, safe and visually attractive access to all destinations on the site.
1033

- 1034 B. Overall Pedestrian and Bicycle Circulation: Pedestrian accessibility provides linkages with
1035 surrounding areas and uses and opens auto-oriented developments to the neighborhood, thereby
1036 reducing traffic impacts and enabling the development to project a friendlier, more inviting image.
1037

1038 Bikeways and pedestrian walkways shall be buffered from external and internal automobile
1039 circulation within parking lots. Walkways are intended to lead pedestrians from parking areas to
1040 building entrances to facilitate convenient movement and to minimize conflicts with cars.
1041 Pedestrians should feel comfortable that they are in a clearly defined pathway to the building. The
1042 development shall:

- 1043
- 1044 1. Locate buildings and design on-site circulation to minimize pedestrian/vehicle conflicts.
 - 1045 2. Separate pedestrian and vehicle movements with the use of landscaping, barriers or other
1046 appropriate design solutions as approved by the Community Development Director.
 - 1047 3. Differentiate areas of pedestrian and bicycle/vehicle interface with accent pavement and
1048 signage to alert drivers to potential conflicts.
 - 1049 4. A minimum of one (1) sidewalk connection between a building and the perimeter street is
1050 required which shall include the following:
 - 1051 a. A minimum six foot (6') wide sidewalk.
 - 1052 b. A minimum four foot (4') wide planter on each side of the sidewalk.
 - 1053 5. The developer shall submit a pedestrian access plan which shows pedestrian paths and
1054 connections with the public sidewalk on the site plan.
 - 1055 6. The following standards shall apply for any commercial, office, or retail building:
 - 1056 a. Provide sidewalks, not less than six (6) feet wide along any facade that contains a
1057 public customer entrance.
 - 1058 b. Except where features such as arcades and entry ways are part of the facade, provide a
1059 six (6) foot wide planting bed between the facade of the building and the adjacent
1060 sidewalk (see Landscape Design, 13.38.5F6).
 - 1061 c. Provide weather protection features such as awnings or arcades within 30 feet of all
1062 customer entrances.

- 1063
- 1064 C. Bicycle Circulation and Parking: Functional and attractive bicycle parking shall be provided in
1065 convenient locations and in adequate numbers for employees and users. The development shall:

- 1066
- 1067 1. Provide bicycle parking in the following minimum ratio:
 - 1068 a. One (1) bicycle space for every 20 required off-street automobile parking spaces up to
1069 a total maximum requirement of 20 bicycle parking spaces per development phase; and
 - 1070 b. A minimum of three (3) bicycle parking spaces shall be provided per lot or building,
1071 regardless of building size. Maintenance buildings may be exempt from this
1072 requirement.

- 1073
1074
1075
1076
1077
1078
1079
1080
1081
1082
1083
1084
1085
1086
1087
1088
1089
1090
1091
1092
1093
1094
1095
1096
1097
1098
1099
1100
2. Bicycle parking is only useful to cyclists if it is located properly. Accordingly, bicycle parking shall be located:
 - a. On the same lot as the principal use;
 - b. To prevent damage to bicycles by cars;
 - c. In a convenient, highly visible, active, well lighted area;
 - d. So as not to interfere with pedestrian movements;
 - e. As near the principal entrance of the building as practical; and
 - f. To provide safe access from the parking spaces to the right of way or bicycle lane.
 3. Both employees and customers shall be considered when determining locations for bicycle parking. For example, a bike rack located within a parking structure may work for employees but would not work well for customers who would normally access the business from an exterior entrance. A highly visible location is determined from the vantage point of someone inside the building or near the principal pedestrian entrance. Locating bicycle parking under a building overhang, or in another way providing a degree of protection from the weather, will greatly improve its convenience.
 4. Appropriate parking facilities include bike racks which allow the bicycle to be supported upright by its frame in two (2) places and should allow the frame and one or both wheels to be secured. For long term employee parking, bike lockers are encouraged. Bicycle parking facilities shall be:
 - a. Consistent with the surroundings in color and design and incorporated, whenever possible, into buildings or street furniture design;
 - b. Designed to allow each bicycle to be supported by its frame;
 - c. Designed to allow the frame and wheels of each bicycle to be secured against theft;
 - d. Designed to avoid damage to the bicycles;
 - e. Anchored to resist rust or corrosion, or removal by vandalism; and
 - f. Designed to accommodate a range of bicycle shapes and sizes and facilitate easy locking without interfering with adjacent bicycles.

1101 **13.38.9: Screen Walls and Fences**

- 1102
1103
1104
1105
1106
1107
1108
1109
1110
1111
1112
1113
1114
1115
1116
1117
1118
1119
1120
1121
1122
1123
1124
1125
1126
1127
- A. Purpose and Intent: Any fence or wall shall be decorative and contribute to the visual quality of the development, used to screen service areas, loading areas, and outdoor storage areas. When not required for security, screening, or grade transitions, fences and walls shall be as inconspicuous and low as possible.
 - B. Wall and Fence Design and Materials: A fence or wall shall be constructed of materials which are compatible with the on-site building architecture. The following shall apply:
 1. A solid perimeter fence or wall shall be constructed adjacent to single family residential land uses.
 2. For retaining walls in excess of 30 inches in height, provide safety protection in the form of railings, fences or hedges, or create a terrace with two (2) shorter walls;
 3. Incorporate architectural treatment on both sides of perimeter walls;
 4. Solid fence or wall runs greater than 50 linear feet shall be articulated with architectural offsets a minimum depth of two (2) feet to incorporate landscape pockets;
 5. Walls: A wall shall consist of concrete, stone, brick, or similar type of solid masonry material and shall conform to structural requirements of the applicable building codes;
 6. Berms: A berm shall be constructed of earthen materials and shall be landscaped;
 7. Solid Fences: A solid fence shall consist of vinyl, precast concrete, masonry, or other similar materials forming an opaque screen and shall conform to structural requirements of the applicable building codes;
 8. Planting: Plant materials used for screening shall be of a type or used in such a manner so as to provide an opaque screen having a minimum width of two feet (2');
 9. Signs: No signs or sign supports shall be permitted on any required screening; and
 10. Elevation Differences: Notwithstanding the requirements listed above where the finished elevation of the property is lower at the boundary line (or within 5 feet inside the boundary

1128 line) than an abutting property elevation, such change in elevation may be used in lieu of, or
1129 in combination with, additional screening to satisfy the screening requirements for this
1130 district.

1131
1132 C. Screening Requirements: A development shall include screening of service areas, refuse and waste
1133 removal areas, loading docks, truck parking areas, outdoor areas used for the display, storage, or sale
1134 of seasonal inventory, and other areas which tend to be unsightly shall be screened using fencing,
1135 walls, and/or landscaping:

- 1136
1137 1. Uses being screened shall not be visible above the screen wall enclosure as viewed from the
1138 public right(s) of way and shall be constructed of materials and finishes to complement the
1139 primary structure;
- 1140 2. Gates and/or access doors shall have self-latching mechanisms and shall be opaque metal or
1141 another acceptable material which is durable. Chain link gates with slats are not permitted;
1142 and
- 1143 3. Screening shall block views to these areas from both on site as well as from public rights of
1144 way, pedestrian walkways, pedestrian bikeways and adjacent properties.

1145
1146 **13.38.10: Sign Design**

1147 A. Please refer to the signage and outdoor advertising standards in 13.26 of the Taylorsville Land
1148 Development Code.

1149
1150 **13.38.11: Exterior Site Lighting**

1151 A. Purpose and Intent: Exterior lighting shall be used to provide illumination for the security and safety
1152 of entry drives, parking, service and loading areas, pathways, courtyards and plazas, without
1153 intruding on adjacent properties. Site lighting shall be architecturally compatible and consistent in
1154 design between sites.

1155
1156 B. Fixture Design: Exterior light fixtures shall be compatible and relate to the architectural character of
1157 the buildings on a site. Site lighting shall be provided at the minimum level to accommodate safe
1158 pedestrian and vehicle movements, without causing any off-site glare.

- 1159
1160 1. Metal halide or other white light fixtures may be used. High-pressure sodium is prohibited in
1161 any application.
- 1162 2. The maximum height of poles within landscaped and plaza areas is 20 feet, measured from
1163 finished grade. Poles within these areas may be set on pedestals no more than eight (8)
1164 inches in height.

1165
1166 C. Decorative Architectural Lighting: Special lighting that accents building features and creates visual
1167 interest is permitted, provided that design continuity is maintained among buildings.

- 1168
1169 1. Neon tubing is not acceptable as a building accent or to accentuate the building's form.
- 1170 2. Lighting fixtures mounted directly on structures may be allowed when utilized to enhance
1171 specific architectural elements or to help establish scale or provide visual interest.
- 1172 3. "Wall pack lights" are permitted only in loading and service areas, and shall be down-lit and
1173 shielded from view.
- 1174 4. Using lighting to highlight entrances, art, terraces, and special landscape features is highly
1175 recommended.

1176
1177 D. Parking Lot Lighting: Parking lot lighting shall be designed to be unobtrusive and to provide safe
1178 light for orderly functions. This chapter requires the following:

- 1179
1180 1. Parking lot light fixtures shall be similar in design to the other lighting in the surface parking
1181 area;

- 1182 2. Lighting shall be selected that has a concealed light source of the "cut-off" variety to prevent
1183 glare onto adjacent buildings and sites;
1184 3. Maximum height of parking lot poles is 24 feet measured from finished grade and shall have
1185 a maximum base height of two (2) feet; and
1186 4. Pedestrian areas in a parking lot shall be well lit.
1187
1188 E. Pedestrian Area Lighting: Walkway lighting shall be scaled to the pedestrian to provide for safe use of
1189 pathways and pedestrian areas. Any walks, stairs, or ramps shall be lighted for the safe passage of
1190 pedestrians. The use of lighted bollards or other low level fixtures is strongly encouraged to identify
1191 pedestrian walkways and drop-off areas at entrances of buildings.
1192
1193 F. Landscape Lighting: Landscape lighting which enhances and complements the landscape materials is
1194 permitted. Where landscape lighting is used, fixtures shall be concealed where possible (i.e. in trees,
1195 behind rocks or shrubs) to control glare.
1196
1197 G. Site Security Lighting: Security lighting may be necessary on some sites, but it may not negatively
1198 impact the site and building architecture or adjacent parcels. No light source (bulb) shall be directly
1199 visible from adjacent parcels.
1200
1201 H. Light Intensity: The light intensity levels within all areas shall correspond to use and potential
1202 hazards. This chapter requires the following:
1203
1204 1. A photometric lighting plan shall be required for all proposed developments to ensure adequate
1205 and appropriate light levels are provided for each site condition;
1206 2. The following levels of illumination shall be maintained for each of the specific locations:
1207
1208 a. Building Entrances 2.0 foot-candles 21.5 lumens/square meter
1209 b. Sidewalks 1.0 foot-candles 10.7 lumens/square meter
1210 c. Bikeways 0.5 foot-candles 5.4 lumens/square meter
1211 d. Courts/Plazas/Terraces 1.0 foot-candles 10.7 lumens/square meter
1212 e. Ramps 3.0 foot-candles 32.3 lumens/square meter
1213 f. Stairways 3.0 foot-candles 32.3 lumens/square meter
1214 g. Parking Lots 1.0 foot-candles 10.7 lumens/square meter
1215 h. Roadways 1.5 foot-candles 16.1 lumens/square meter
1216 i. Gas Station Canopy 10.0 foot-candles 107.6 lumens/square meter
1217
1218 3. As used in this chapter, "values given" means the area in minimum average maintained
1219 horizontal, foot-candles (lumens/square meter) which are measured at the average point of
1220 illumination between brightest and darkest areas, 4'-5' above the ground surface; and
1221 4. Metric conversions are provided for convenience only. Photometric plans shall be submitted
1222 for approval using imperial measurement values.

1 **13.36.020: "A" DEFINITIONS**

2
3 **ASSISTED LIVING FACILITY:**

- 4
5 A. A residential facility, licensed by the state of Utah, with a homelike setting that provides an array of
6 coordinated supportive personnel and healthcare services, available twenty four (24) hours per day,
7 to residents who have been assessed under Utah department of health or Utah department of human
8 services rules to need any of these services. Each resident shall have a service plan based on the
9 assessment, which may include:
- 10
 - 11 1. Specified services of intermittent nursing care.
 - 12 2. Administration of medication.
 - 13 3. Support services promoting residents' independence and self-sufficiency.
- 14
- 15 B. An assisted living facility does not include:
- 16
 - 17 1. A "residential facility for persons with a disability" (defined elsewhere in this chapter).
 - 18 2. Adult daycare provided in conjunction with a residential facility for elderly persons or a
19 residential facility for persons with a disability.
- 20
- 21 C. Assisted living facilities are broken down into two (2) classes:
- 22
 - 23 1. Limited capacity assisted living facility: A facility accommodating not more than four (4)
24 residents, excluding staff. All residents must be ambulatory which means a person who is
25 capable of achieving mobility sufficient to exit a structure without the assistance of another
26 person. Adult daycare shall not be provided as part of the facility (see definition of Human
27 Services Programs or Facilities.)
 - 28 2. Large capacity assisted living facility: A facility accommodating more than four (4) residents,
29 excluding staff. Adult daycare may be approved separately as provided elsewhere.
- 30

31 **ASSISTED LIVING UNIT:**

32 A dwelling unit varying in square footage that provides a residential living environment assisted by
33 congregate meals, housekeeping and personal services for persons age fifty-five (55) or older, who have
34 temporary or periodic difficulties with one (1) or more essential activities of daily living, such as feeding,
35 bathing, dressing or mobility. As assisted living unit shall include accessory uses, including dining rooms,
36 bathing areas, common areas, offices and other necessary to provide the above services.

37
38 **13.36.040: "C" DEFINITIONS**

39
40 **CONTINUING CARE RETIREMENT COMMUNITY:**

41 A facility which has a primary purpose of providing housing and continuing care for people over the age of
42 fifty-five (55) or where either the husband or wife is over age fifty-five (55), consists of independent
43 apartment units, assisted living units, skilled care nursing units, senior apartment units, senior cottage units,
44 and continuing care retirement community accessory uses all as defined herein. For purposes of this Part
45 "continuing care" means the provision of lodging, nursing, medical or health related services at the same or
46 another location to an individual pursuant to an agreement effective for the life of the individual or for a
47 period greater than one (1) year, including mutually terminable contracts and in consideration of the
48 payment of an entrance fee with or without other periodic charges.

49
50 **CONTINUING CARE RETIREMENT COMMUNITY ACCESSORY USES:**

51 Any use necessary for the operation of the facility or for the benefit or convenience of the residents and their
52 guests including, but not limited to, kitchen and dining facilities, places of worship, indoor and outdoor
53 recreational buildings and uses, retail and banking facilities, beauty salons and barber shops, gift shops, class
54 rooms, security facilities, conference rooms, common areas, guest rooms, administrative offices, medical
55 offices, physical rehab facilities, postal center, pharmacy, maintenance facilities, craft and music rooms,

56 library and television room and heating and cooling equipment structures; provided, that the accessory use is
57 for the primary benefit of the continuing care retirement community and provided that there is no exterior
58 announcement of the use.

59
60 **13.36.100: "I" DEFINITIONS**

61
62 **INDEPENDENT APARTMENT UNIT:**

63 A dwelling unit containing living areas, bedroom areas, kitchen areas and bathrooms, including studio style
64 apartments, varying in square footage from six hundred fifty (650) square feet to two thousand (2,000)
65 square feet, which house one (1) or more people over the age of fifty-five (55) in a manner in which they may
66 live independently while receiving one (1) or more meals per day in congregate setting.

67
68 **13.36.200: "S" DEFINITIONS**

69
70 **SENIOR APARTMENT UNITS:**

71 Single-family dwelling units within a single building for persons age fifty-five (55) and older.

72
73 **SKILLED NURSING CARE UNIT:**

74 A nursing bed or individual room which provides board, shelter and twenty-four (24) hour skilled nursing
75 and medical care to chronic or convalescent patients. A nursing unit shall include accessory uses, including
76 dining rooms, bathing areas, common areas, offices, clinics, therapy areas, medical facilities and other space
77 necessary to provide the above services.

Exhibit "D"

Retirement Community Phasing Plan

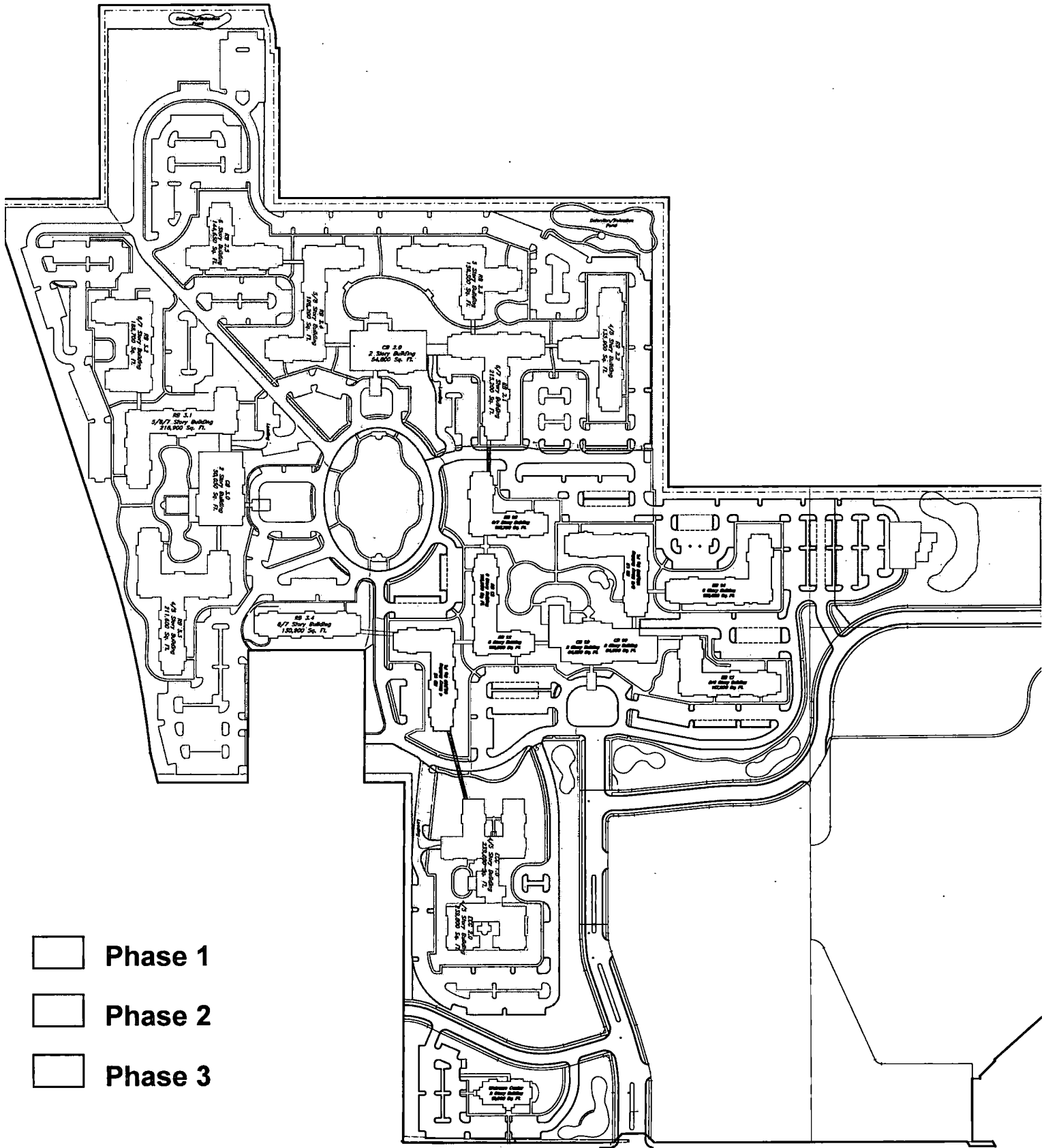

- Phase 1
- Phase 2
- Phase 3

Note: Fencing and required landscaping buffers adjacent to existing residential land uses will be installed within 24 months of the date of this Development Agreement.

EXHIBIT "D"

Retirement Community Phasing Plan (cont'd)

PHASE 1

Building Type	Square Feet	Stories
Residential Building 1.1	146,800	6
Residential Building 1.2	147,500	5/6
Residential Building 1.3	160,950	5/6
Residential Building 1.4	99,350	4
Residential Building 1.5	165,400	6
Residential Building 1.6	146,750	6/7
Welcome Center	19,900	2
Gatehouse	120	1
Community Building 1.0	59,950	2
TOTAL (PHASE 1)	946,720	

Phase 2

Building Type	Square Feet	Stories
Residential Building 2.1	215,200	6/7
Residential Building 2.2	156,300	5
Residential Building 2.3	135,900	0.8
Residential Building 2.4	196,200	5/6
Residential Building 2.5	144,650	6
Extended Care Center 1.0	119,900	4/5
Community Building 2.0	54,800	2
Maintenance Shed	4,000	1
Garden Shed	150	1
TOTAL (PHASE 2)	1,027,100	

Phase 3

Building Type	Square Feet	Stories
Residential Building 3.1	218,900	5/6/7
Residential Building 3.2	186,700	6/7
Residential Building 3.3	211,600	4/5
Residential Building 3.4	130,900	6/7
Community Building 3.0	50,050	2
Extended Care Center 2.0	119,900	4/5
TOTAL (PHASE 3)	918,050	

PROJECT TOTAL **2,891,870**

EXHIBIT "E"

COMMUNITY DEVELOPMENT FEE SCHEDULE

SUBDIVISION REVIEW:

Subdivision application (preliminary)	\$ 200.00 plus \$10 .00 per lot
Subdivision application (final review)	6 percent of the cost of improvements
For a final subdivision review, the applicant shall pay a fee of ninety dollars (\$90.00) per lot to initiate the City review. This fee per lot shall apply toward the final subdivision review fee.	
Amendment to the existing subdivision	\$ 100.00 plus \$25 .00 per lot

(Ord. 96-37, 9-11-1996; amd. Ord. 12-15, 7-11-2012)

LAND DEVELOPMENT CODE AMENDMENTS:

Applications for amendment to the zoning map	\$ 100.00 plus \$50 .00 per acre
Text change amendments to the land development code	\$ 300.00
City general plan amendment	\$ 300.00 plus \$50.00 per acre

(Ord. 96-37, 9-11-1996; amd. Ord. 12-15, 7-11-2012; Ord. 96-37, 9-11-1996)

CONDITIONAL USE PERMIT APPLICATIONS:

Residential use:	
Preliminary review	\$ 100.00 plus \$10.00 per unit
Final review	\$ 250.00 plus \$20.00 per unit
Non-Residential:	
Preliminary review	\$ 100.00 plus \$50.00 per acre
Final review	\$ 250.00 plus \$100.00 per acre
Conditional use amendment	\$ 50.00

(Ord. 96-37, 9-11-1996)

OTHER APPLICATIONS AND IMPACT FEES:

Sign review	\$ 35.00
Street vacation	\$ 100.00
Park impact fee:	
Single-Family Dwelling Unit	\$1,290.00
Multi-Family Dwelling Unit	\$ 920.53 per unit
Storm water impact fee ¹	(Development runoff + 854) x \$5,019,696.00 = gross fees

¹. Total runoff for each separate development, as well as for the basin areas, is calculated according to the following standard methodology used by engineers:

where $q = cia$
 q = total development runoff
 c = imperviousness of development
 i = drainage area intensity
 a = acres of development

(Ord. 07-36, 12-5-2007; amd. Ord. 12-15, 7-11-2012; Ord. 97-32, 8-20-1997; Ord. 01-03, 1-17-2001; Ord. 96-37, 9-11-1996)

GUARANTEES FOR IMPROVEMENTS:

Required as per 13.02.160 of the Taylorsville Land Development Code.

(Ord. 12-15, 7-11-2012)

Exhibit "F" Road and Related Improvements

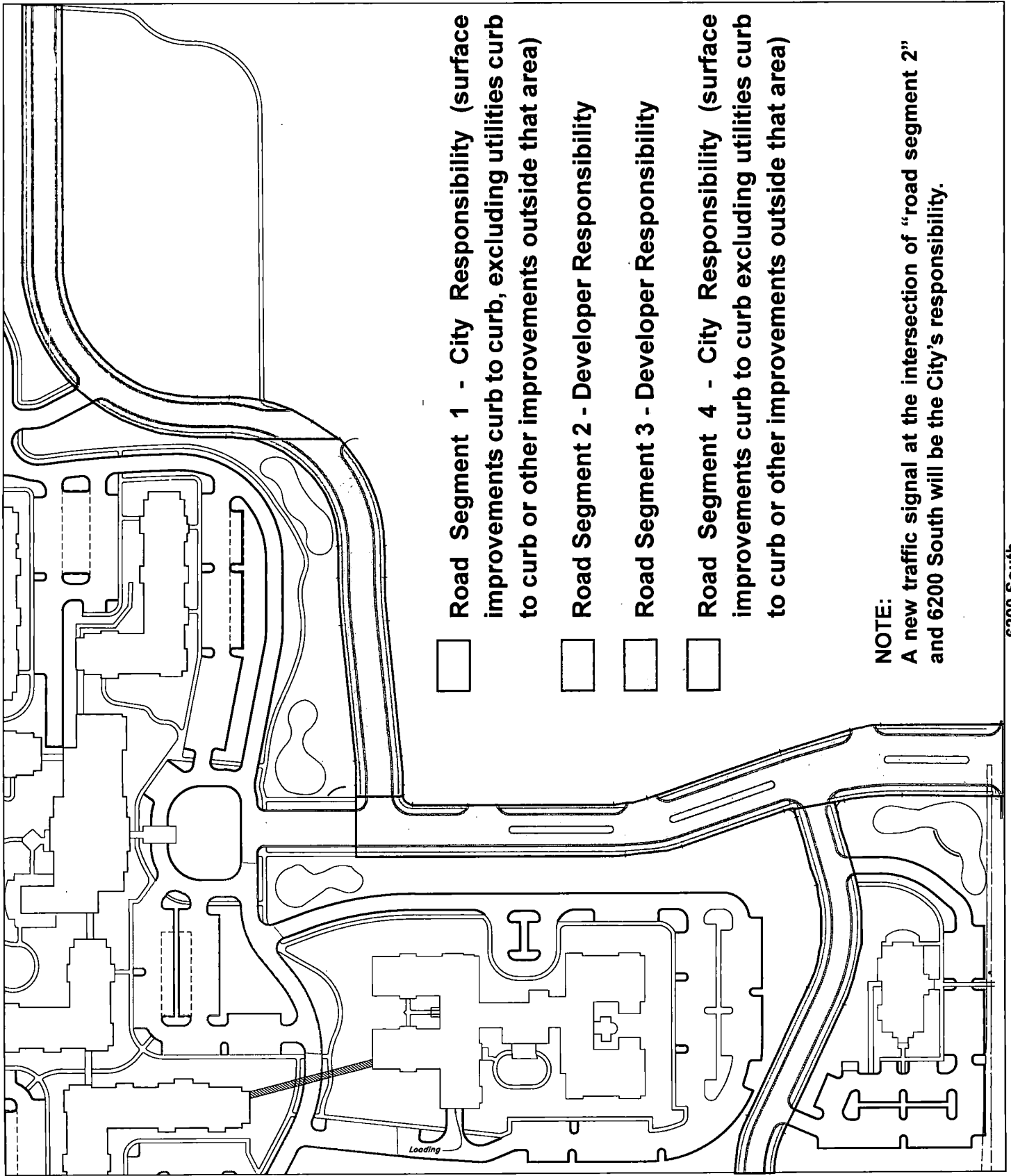

3200 West

- Road Segment 1 - City Responsibility (surface improvements curb to curb, excluding utilities curb to curb or other improvements outside that area)
- Road Segment 2 - Developer Responsibility
- Road Segment 3 - Developer Responsibility
- Road Segment 4 - City Responsibility (surface improvements curb to curb excluding utilities curb to curb or other improvements outside that area)

NOTE:
A new traffic signal at the intersection of "road segment 2" and 6200 South will be the City's responsibility.

6135 South

6200 South

EXHIBIT "F" (cont'd)

Section Locations

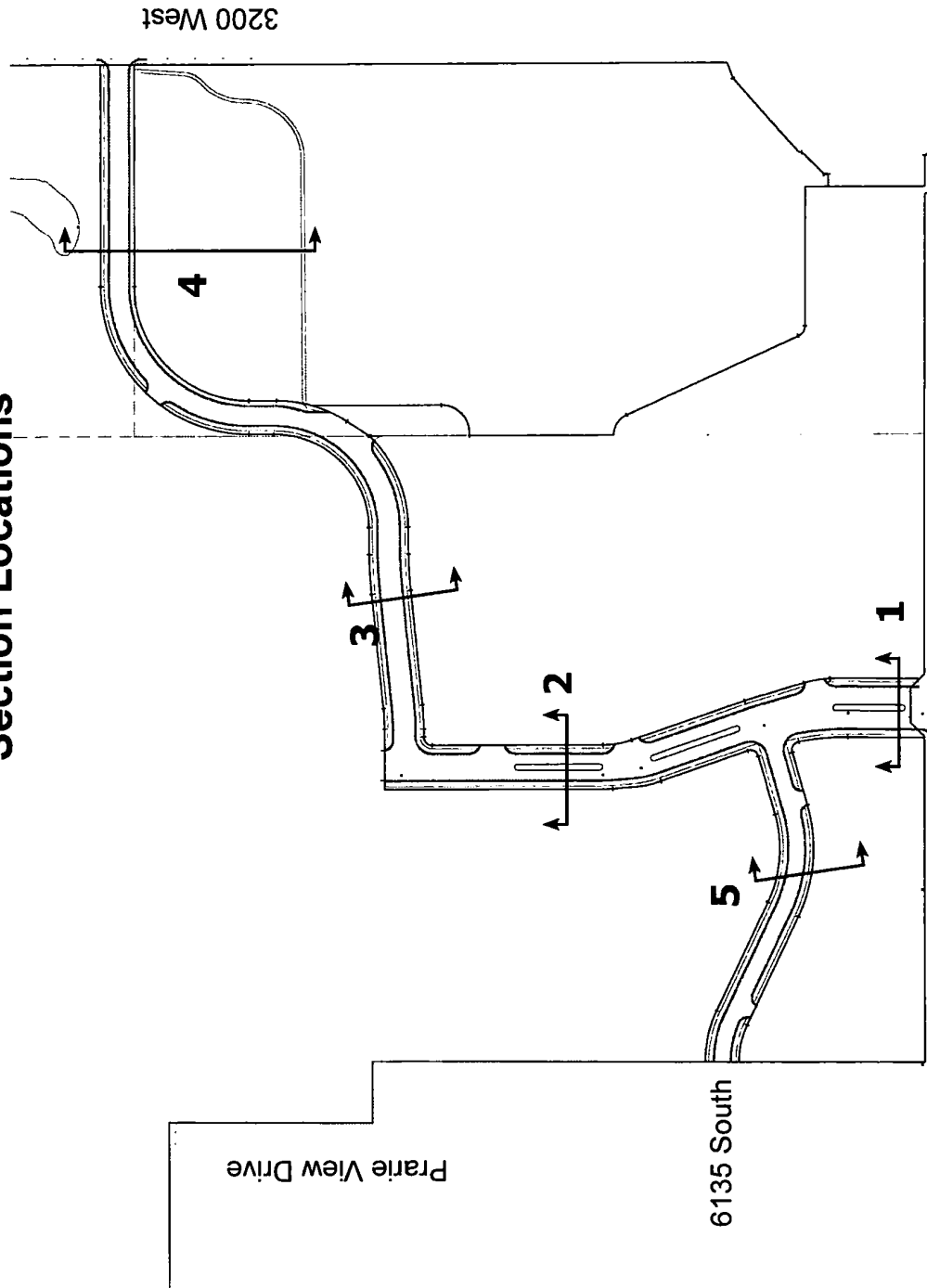

6200 South / Bennion Blvd.

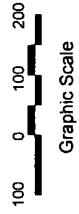

EXHIBIT "F" (cont'd)

Section 1

106' Right of Way

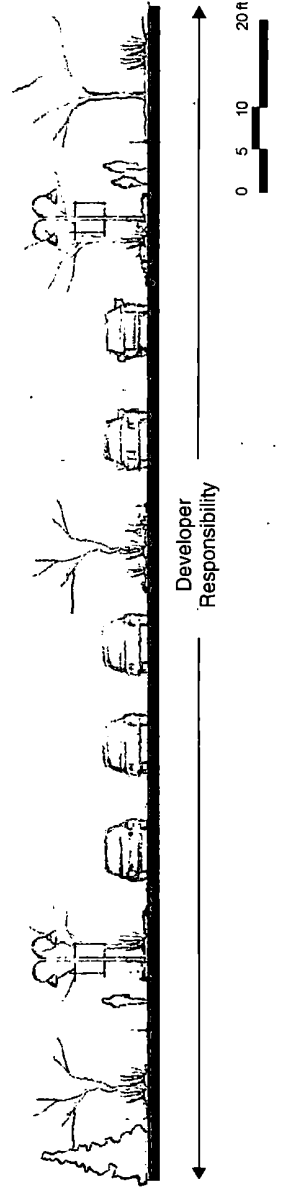
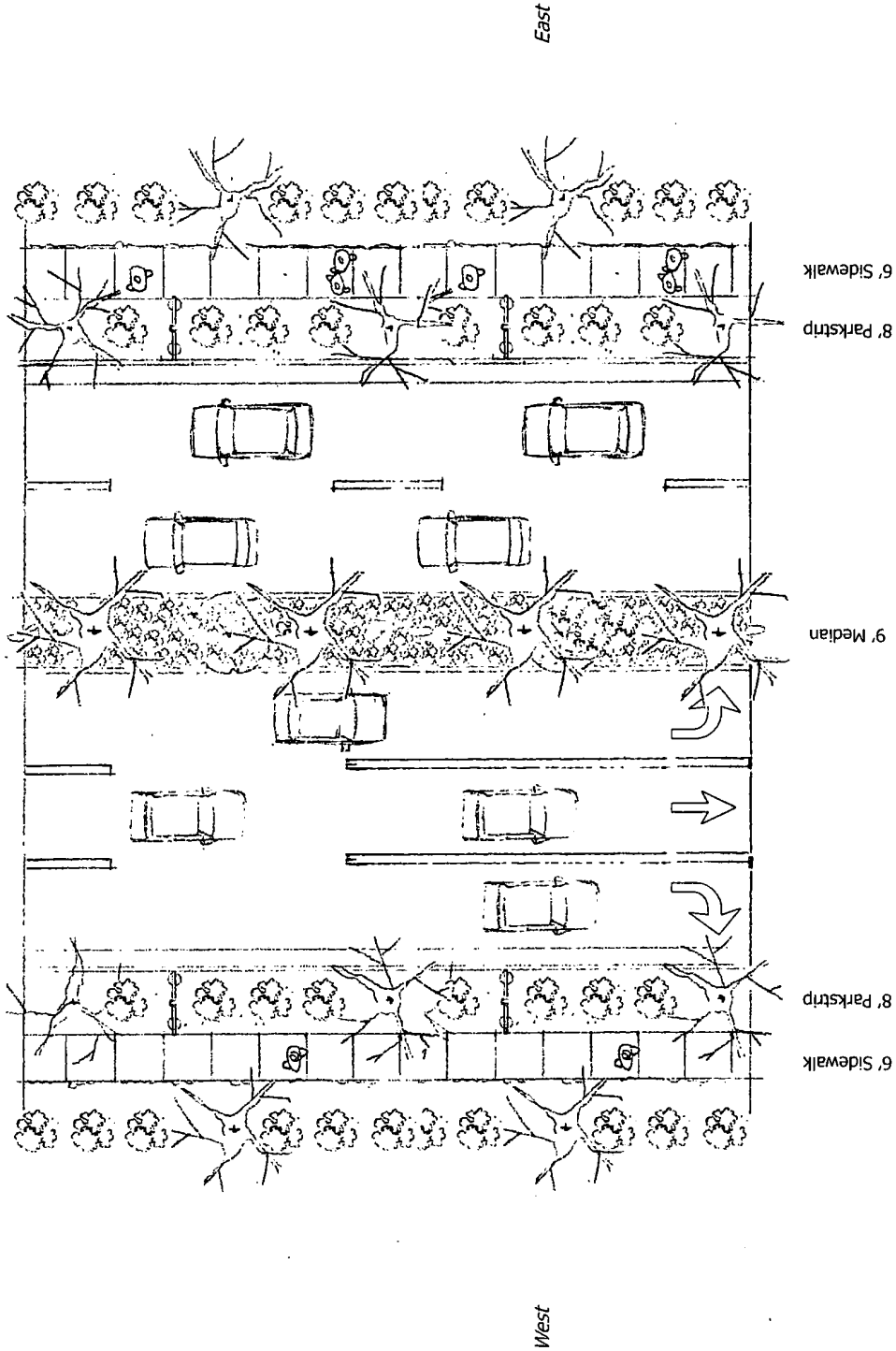

EXHIBIT "F" (cont'd)

Section 2

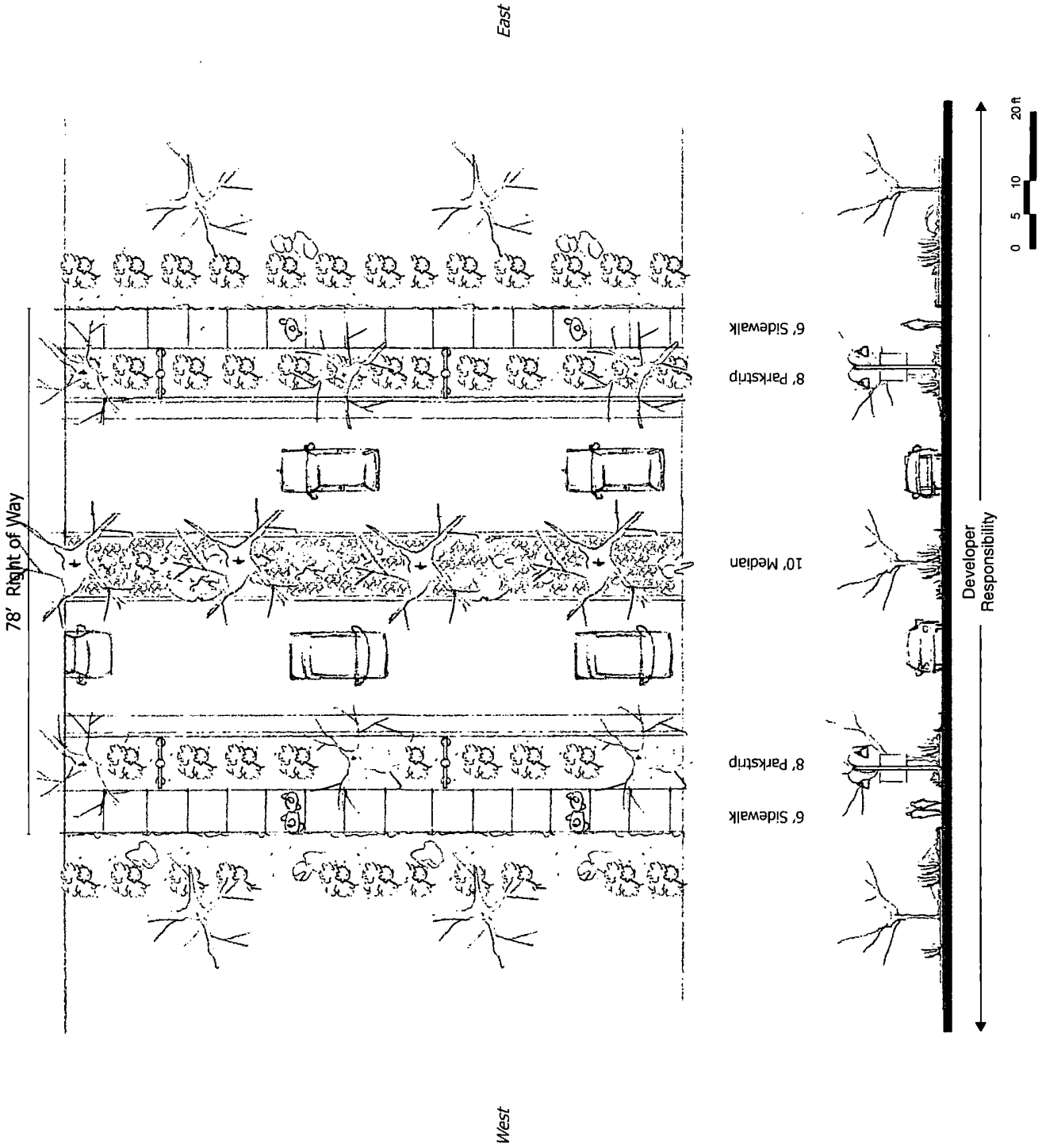

EXHIBIT "F" (cont'd)

Section 4

60' Right of Way

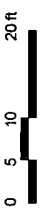
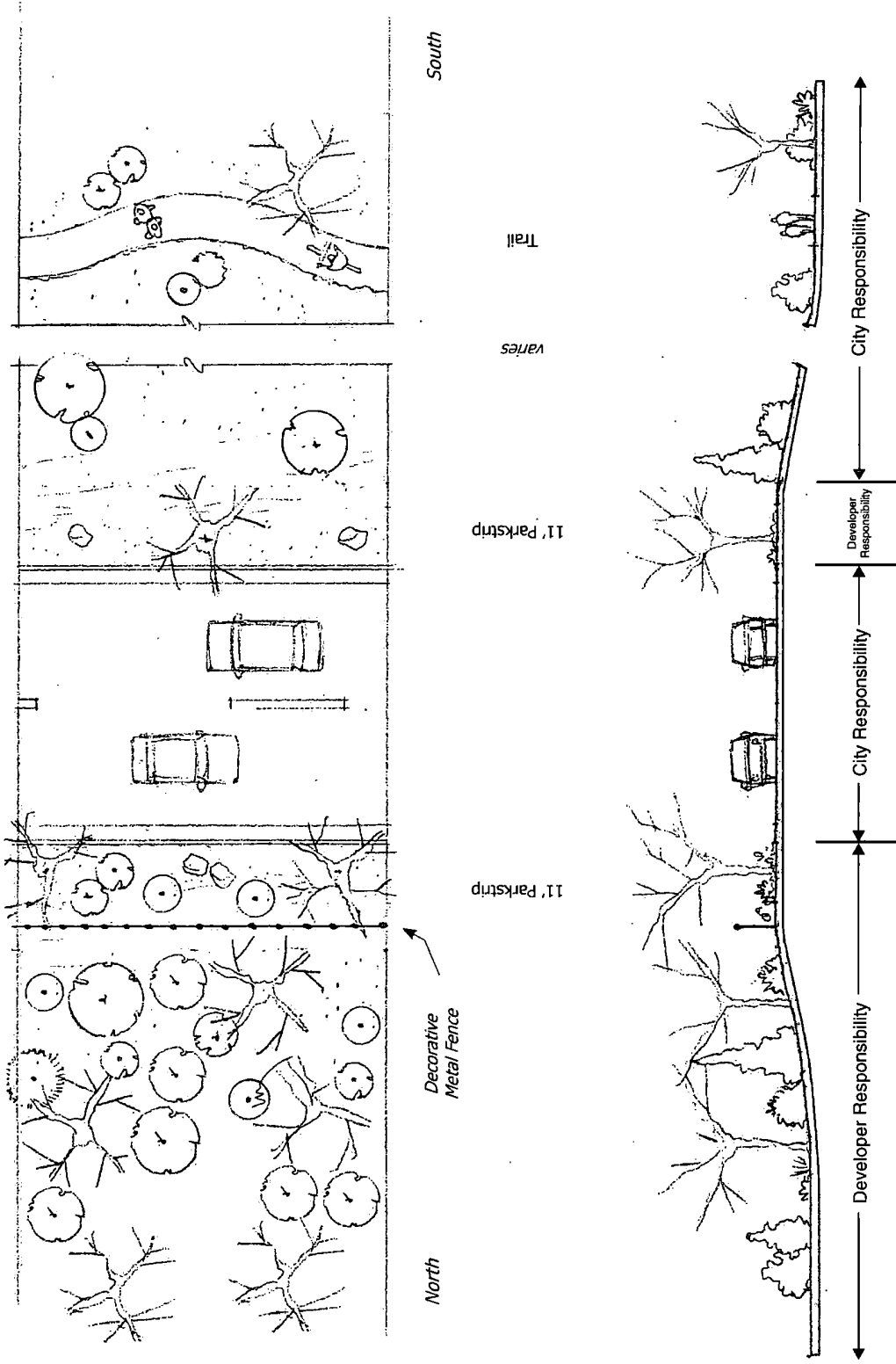

EXHIBIT "F" (cont'd)

Section 5

60' Right of Way

